



# Accessories Catalog





# Get the most out of your tools

Ingersoll Rand takes a systematic approach to providing a complete solution to maximize your productivity as efficiently and safely as possible. To that end, we have organized our extensive line of tool accessories in the following categories:

- **Air Line Accessories** — featuring products for air treatment and transport, including FRLs, hoses, couplers, and plugs.
- **Consumables and Attachments** — these are the items physically performing the work, including impact sockets, tool steels, abrasives and pads, drill and nutrunner bits, burs, stones, and reciprocating saw blades.
- **Ergonomic Accessories** — products specifically designed to help you perform your job more efficiently and safely, such as spring balancers, torque reaction arms, grips, and braces.
- **Maintenance Accessories** — lubricants and grease guns help maximize performance by helping keep your tools up and running.

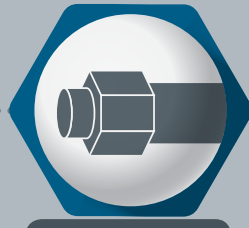

Air Line Accessories



Filters, Regulators, & Lubricators 4



Hoses & Fittings 23

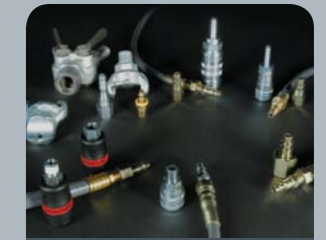

Couplers & Plugs 28



Consumables & Attachments



Impact Sockets 34



Pneumatic Tool Steels 72



Abrasives & Pads 97



Burs, Stones, & Collets 105



Air Reciprocating Saw Blades 109



Drill & Nutrunner Bits 111



Ergonomic Accessories



Spring Balancers 124



Torque Reaction Arms 129



Grips & Braces 133



Maintenance Accessories



Lubricants & Grease Guns 135

Air Line

Consumables & Attachments

Ergonomic

Maintenance

# Filters, Regulators, & Lubricators



## Selections

When selecting an FRL or individual filter, regulator, and lubricator units, the air consumption of the tools or equipment to be serviced should be correlated with the flow capacity of the FRL. ARO Filters, Regulators, and Lubricators are designed to flow in excess of that indicated in the maximum recommended flow table shown below. This table gives recommended flows for pipe sizes at listed pressures and should be used as a guide in sizing piping and equipment for compressed air systems.

Maximum recommended air flow (scfm) thru ANSI standard weight Schedule 40 pipe

Applied Pressure PSIG	Nominal Standard Pipe Size — Inches										
	1/8"	1/4"	3/8"	1/2"	3/4"	1"	1-1/4"	1-1/2"	2"	2-1/2"	3"
5	0.5	1.2	2.7	4.9	6.6	13	27	40	80	135	240
10	0.8	1.7	3.9	7.7	11.0	21	44	64	125	200	370
20	1.3	3.0	6.6	13.0	18.5	35	75	110	215	350	600
40	2.5	5.5	12.0	23.0	34.0	62	135	200	385	640	1100
60	3.5	8.0	18.0	34.0	50.0	93	195	290	560	900	1600
80	4.7	10.5	23.0	44.0	65.0	120	255	380	720	1200	2100
100	5.8	13.0	29.0	54.0	80.0	150	315	470	900	1450	2600
150	8.6	20.0	41.0	80.0	115	220	460	680	1350	2200	3900
200	11.5	26.0	58.0	108.0	155.0	290	620	910	1750	2800	5000
250	14.5	33.0	73.0	135.0	200	370	770	1150	2200	3500	6100

The flow values in the chart above are based upon a pressure drop ( $\Delta P$ ) as set forth in the following schedule:

Pressure Drop ( $\Delta P$ ) per 100 ft. of Pipe	Pipe Size — Inches
10% of Applied Pressure	1/8, 1/4, 3/8, 1/2
5% of Applied Pressure	3/4, 1, 1-1/4, 1-1/2, 2, 2-1/2, 3

## Installation

The filter, regulator, and lubricator should be installed in the order shown in the illustration below. If a coalescing filter is required, it should be installed downstream from a standard filter. Individual take-off lines to the FRL and air tool or equipment should be from the top of the compressed air line. Make sure that air flow markings are followed for proper flow direction through the FRL units. To trap and expel water, sludge and other contaminants which may collect on the bottom of the air line, a drip leg drain should be used. Drip leg drains should be installed at low points in the piping system and at the far end of the distribution system.

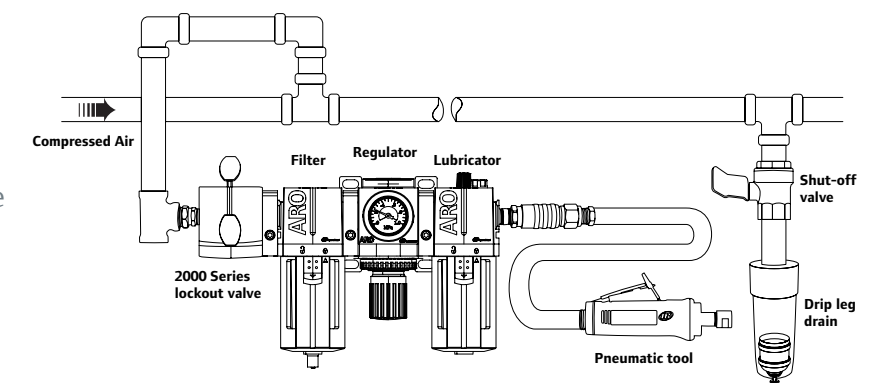

For further model options, port sizes, and information regarding flow charts, unit dimensions, replacement parts, and more, go to:

[ingersollrandproducts.com/accessories](https://www.ingersollrandproducts.com/accessories)



# Filters

1000, 1500, 2000, & 3000 Series

1/8" • 1/4" • 3/8" • 1/2" • 3/4" • 1" Ports

ARO-Flo compressed air filters are designed to remove airborne solid and liquid contaminants. Filters can be ordered with different elements, including coalescing models which are capable of removing oil aerosols and particles down to 0.3 micron. Standard filters are sold with 5-micron elements; 40-micron elements can be purchased and installed separately.



### Technical Data

		SERIES			
		1000	1500	2000	3000
Auto drain	Acetal	•	•	•	•
Standard filter	Polyethylene	•	•	•	•
Coalescing filter	HEPA paper & felt	•	•	•	•
Seals	Nitrile	•	•	•	•
Filter baffle	Acetal	•	•	•	•
Polycarbonate bowl	Polycarbonate	•	•	•	—
Polycarbonate bowl w/ guard	Nylon	•	•	•	—
Metal bowl	Aluminum	•	•	•	•
Filter body	Aluminum	•	•	•	•
Manual drain	Brass & nitrile	•	•	•	•
Metal bowl w/ sight glass	Nylon	—	•	•	•

SERIES	POLYCARBONATE BOWL	METAL BOWL / METAL BOWL W/ SIGHT GLASS
<b>Max Inlet Pressure (psi)</b>		
1000	150	250
1500	150	250
2000	150	250
3000	—	250
<b>Temperature Range (°F)</b>		
1000	23 – 125	23 – 175
1500	23 – 125	23 – 175
2000	23 – 125	23 – 175
3000	—	23 – 175

## 1000 Series

NPT	Filter Type	Bowl Cap	Filter Element	cfm*	Model
<b>MANUAL DRAIN • METAL BOWLS</b>					
1/8"	Coalescing	0.3	0.3	38	F35111-320
1/8"	Standard	0.4	5	38	F35111-420
1/4"	Coalescing	0.3	0.3	49	F35121-320
1/4"	Standard	0.4	5	49	F35121-420
<b>MANUAL DRAIN • POLYCARBONATE BOWLS W/ GUARD</b>					
1/8"	Coalescing	0.3	0.3	38	F35111-300
1/8"	Standard	0.5	5	38	F35111-400
1/4"	Coalescing	0.3	0.3	49	F35121-300
1/4"	Standard	0.5	5	49	F35121-400
<b>AUTO DRAIN • METAL BOWLS</b>					
1/8"	Coalescing	0.5	0.3	38	F35111-321
1/8"	Standard	0.7	5	38	F35111-421
1/4"	Coalescing	0.5	0.3	49	F35121-321
1/4"	Standard	0.7	5	49	F35121-421
<b>AUTO DRAIN • POLYCARBONATE BOWLS W/ GUARD</b>					
1/8"	Coalescing	0.5	0.3	38	F35111-301
1/8"	Standard	0.7	5	38	F35111-401
1/4"	Coalescing	0.5	0.3	49	F35121-301
1/4"	Standard	0.7	5	49	F35121-401

## 1500 Series

NPT	Filter Type	Bowl Cap	Filter Element	cfm*	Model
<b>MANUAL DRAIN • POLYCARBONATE BOWLS W/ GUARD</b>					
1/4"	Coalescing	1.2	0.3	73	F35221-300
1/4"	Standard	1.3	5	73	F35221-400
3/8"	Coalescing	1.2	0.3	107	F35231-300
3/8"	Standard	1.3	5	107	F35231-400
<b>MANUAL DRAIN • METAL BOWLS</b>					
1/4"	Coalescing	1.2	0.3	73	F35221-320
1/4"	Standard	1.3	5	73	F35221-420
3/8"	Coalescing	1.2	0.3	107	F35231-320
3/8"	Standard	1.3	5	107	F35231-420
<b>MANUAL DRAIN • METAL BOWLS W/ SIGHT GLASS</b>					
1/4"	Coalescing	1.2	0.3	73	F35221-310
1/4"	Standard	1.3	5	73	F35221-410
3/8"	Coalescing	1.2	0.3	107	F35231-310
3/8"	Standard	1.3	5	107	F35231-410
<b>AUTO DRAIN • POLYCARBONATE BOWLS W/ GUARD</b>					
1/4"	Coalescing	1.0	0.3	73	F35221-301
1/4"	Standard	1.0	5	73	F35221-401
3/8"	Coalescing	1.0	0.3	107	F35231-301
3/8"	Standard	1.0	5	107	F35231-401
<b>AUTO DRAIN • METAL BOWLS W/ SIGHT GLASS</b>					
1/4"	Coalescing	1.0	0.3	73	F35221-311
1/4"	Standard	1.0	5	73	F35221-411
3/8"	Coalescing	1.0	0.3	107	F35231-311
3/8"	Standard	1.0	5	107	F35231-411

## 2000 Series

NPT	Filter Type	Bowl Cap	Filter Element	Service Indicator	cfm*	Model
<b>MANUAL DRAIN • POLYCARBONATE BOWLS W/ GUARD</b>						
3/8"	Standard	1.9	5	None	156	F35331-400
3/8"	Coalescing	1.9	0.3	Mechanical	156	F35332-300
1/2"	Standard	1.9	5	None	197	F35341-400
1/2"	Coalescing	1.9	0.3	Mechanical	197	F35342-300
3/4"	Standard	1.9	5	None	216	F35351-400
<b>MANUAL DRAIN • METAL BOWLS</b>						
3/8"	Standard	2.4	5	None	156	F35331-420
3/8"	Coalescing	2.4	0.3	Mechanical	156	F35332-320
1/2"	Standard	2.4	5	None	197	F35341-420
1/2"	Coalescing	2.4	0.3	Mechanical	197	F35342-320
<b>MANUAL DRAIN • METAL BOWLS W/ SIGHT GLASS</b>						
3/8"	Standard	2.4	5	None	156	F35331-410
3/8"	Coalescing	2.4	0.3	Mechanical	156	F35332-310
1/2"	Standard	2.4	5	None	197	F35341-410
1/2"	Coalescing	2.4	0.3	Mechanical	197	F35342-310
3/4"	Standard	2.4	5	None	216	F35351-410
<b>AUTO DRAIN • POLYCARBONATE BOWLS W/ GUARD</b>						
3/8"	Standard	2.3	5	None	156	F35331-401
3/8"	Coalescing	2.3	0.3	Mechanical	156	F35332-301
1/2"	Standard	2.3	5	None	197	F35341-401
1/2"	Coalescing	2.3	0.3	Mechanical	197	F35342-301
3/4"	Standard	2.3	5	None	216	F35351-401
<b>AUTO DRAIN • METAL BOWLS W/ SIGHT GLASS</b>						
3/8"	Standard	2.8	5	None	156	F35331-411
3/8"	Coalescing	2.8	0.3	Mechanical	156	F35332-311
1/2"	Standard	2.8	5	None	197	F35341-411
1/2"	Coalescing	2.8	0.3	Mechanical	197	F35342-311
3/4"	Standard	2.8	5	None	216	F35351-411

## 3000 Series

NPT	Filter Type	Bowl Cap	Filter Element	Service Indicator	cfm*	Model
<b>MANUAL DRAIN • METAL BOWLS</b>						
3/4"	Coalescing	4.7	0.3	Mechanical	288	F35452-320
3/4"	Standard	5.3	5	None	288	F35451-420
3/4"	Standard	5.3	5	Mechanical	288	F35452-420
1"	Coalescing	4.7	0.3	Mechanical	353	F35462-320
1"	Standard	5.3	5	None	353	F35461-420
1"	Standard	5.3	5	Mechanical	353	F35462-420
<b>MANUAL DRAIN • METAL BOWLS W/ SIGHT GLASS</b>						
3/4"	Coalescing	4.7	0.3	Mechanical	288	F35452-310
3/4"	Standard	5.3	5	None	288	F35451-410
3/4"	Standard	5.3	5	Mechanical	288	F35452-410
1"	Coalescing	4.7	0.3	Mechanical	353	F35462-310
1"	Standard	5.3	5	None	353	F35461-410
1"	Standard	5.3	5	Mechanical	353	F35462-410
<b>AUTO DRAIN • METAL BOWLS</b>						
3/4"	Coalescing	5.2	0.3	Mechanical	288	F35452-321
3/4"	Standard	5.9	5	None	288	F35451-421
3/4"	Standard	5.9	5	Mechanical	288	F35452-421
1"	Coalescing	5.2	0.3	Mechanical	353	F35462-321
1"	Standard	5.9	5	None	353	F35461-421
1"	Standard	5.9	5	Mechanical	353	F35462-421
<b>AUTO DRAIN • METAL BOWLS W/ SIGHT GLASS</b>						
3/4"	Coalescing	5.2	0.3	Mechanical	288	F35452-311
3/4"	Standard	5.9	5	None	288	F35451-411
3/4"	Standard	5.9	5	Mechanical	288	F35452-411
1"	Coalescing	5.2	0.3	Mechanical	353	F35462-311
1"	Standard	5.9	5	None	353	F35461-411
1"	Standard	5.9	5	Mechanical	353	F35462-411

\*Inlet pressure 90 psi (6.2 bar) with 10 psi drop (0.7 bar)

For further model options, port sizes, and information regarding flow charts, unit dimensions, replacement parts, and more, go to:

[ingersollrandproducts.com/accessories](http://ingersollrandproducts.com/accessories)



# Regulators

1000, 1500, 2000, & 3000 Series

1/8" • 1/4" • 3/8" • 1/2" • 3/4" • 1" Ports

Air line regulators provide controlled, consistent air pressure as required for specific pneumatic equipment connected to the air system. All ARO-Flo regulators are offered with a standard adjustment range of 0 – 140 psig (0 – 9.6 barg). Alternative spring ranges are offered for easy conversion to suit different requirements. Non-relieving regulators are offered for applications where the venting of downstream overpressure is undesirable.



Adjustment range can exceed spring rating on 0 – 30 psi and 0 – 60 psi regulators. The working range of the adjustment knob is designed to permit outlet pressures beyond the spring ratings in the 0 – 30 psi and 0 – 60 psi models. The adjustment knob is not designed to be a pressure limiting device. Limiting devices may be obtained only by special design. For optimal performance, regulators should not be set to ranges outside the specified spring range.

### Technical Data

		SERIES			
		1000	1500	2000	3000
<b>Diaphragm</b>	Nitrile & nylon	–	•	•	•
	Nitrile & acetal	•	–	–	–
<b>Regulator body</b>	Aluminum	•	•	•	•
<b>Regulator valve</b>	Nitrile & nylon	–	•	•	•
	Brass & nitrile	•	–	–	–
<b>Regulator springs</b>	Steel	•	•	•	•
<b>Gauge cover</b>	Nylon & polycarbonate	•	•	•	•
<b>Regulator knob</b>	Acetal	•	•	•	•
<b>O-rings</b>	Nitrile	•	•	•	•

SERIES	MAX INLET PRESSURE (psi)	TEMPERATURE RANGE (°F)	SPRING RANGE OPTIONS (psi)
<b>1000</b>	250	23 – 140	0 – 30
			0 – 60
			0 – 140
<b>1500</b>	250	23 – 140	0 – 30
			0 – 60
			0 – 140
<b>2000</b>	250	23 – 140	0 – 30
			0 – 60
			0 – 140
<b>3000</b>	250	23 – 140	0 – 30
			0 – 60
			0 – 140

## 1000 Series

NPT	Pressure Range psi	Gauge	cfm*	Model
<b>RELIEVING • STANDARD KNOB CONTROL</b>				
1/8"	0 – 30	No gauge	45	R37111-400
1/8"	0 – 60	No gauge	45	R37111-200
1/8"	0 – 140	No gauge	45	R37111-100
1/8"	0 – 140	Flush-mount gauge	45	R37111-600
1/4"	0 – 30	No gauge	59	R37121-400
1/4"	0 – 60	No gauge	59	R37121-200
1/4"	0 – 140	No gauge	59	R37121-100
1/4"	0 – 140	Flush-mount gauge	59	R37121-600
<b>NON-RELIEVING • STANDARD KNOB CONTROL</b>				
1/8"	0 – 30	No gauge	45	R37111-420
1/8"	0 – 60	No gauge	45	R37111-220
1/8"	0 – 140	No gauge	45	R37111-120
1/8"	0 – 140	Flush-mount gauge	45	R37111-620
1/4"	0 – 30	No gauge	59	R37121-420
1/4"	0 – 60	No gauge	59	R37121-220
1/4"	0 – 140	No gauge	59	R37121-120
1/4"	0 – 140	Flush-mount gauge	59	R37121-620

## 1500 Series

NPT	Pressure Range psi	Gauge	cfm*	Model
<b>RELIEVING • STANDARD KNOB CONTROL</b>				
1/4"	0 – 30	No gauge	86	R37221-400
1/4"	0 – 60	No gauge	86	R37221-200
1/4"	0 – 140	No gauge	86	R37221-100
1/4"	0 – 140	Flush-mount gauge	86	R37221-600
3/8"	0 – 30	No gauge	113	R37231-400
3/8"	0 – 60	No gauge	113	R37231-200
3/8"	0 – 140	No gauge	113	R37231-100
3/8"	0 – 140	Flush-mount gauge	113	R37231-600
<b>NON-RELIEVING • STANDARD KNOB CONTROL</b>				
1/4"	0 – 30	No gauge	86	R37221-420
1/4"	0 – 60	No gauge	86	R37221-220
1/4"	0 – 140	No gauge	86	R37221-120
1/4"	0 – 140	Flush-mount gauge	86	R37221-620
3/8"	0 – 30	No gauge	113	R37231-420
3/8"	0 – 60	No gauge	113	R37231-220
3/8"	0 – 140	No gauge	113	R37231-120
3/8"	0 – 140	Flush-mount gauge	113	R37231-620

## 2000 Series

NPT	Pressure Range psi	Gauge	cfm*	Model
<b>RELIEVING • STANDARD KNOB CONTROL</b>				
3/8"	0 – 30	No gauge	179	R37331-400
3/8"	0 – 60	No gauge	179	R37331-200
3/8"	0 – 140	No gauge	179	R37331-100
3/8"	0 – 140	Flush-mount gauge	179	R37331-600
3/8"	10 – 200	No gauge	179	R37331-300
1/2"	0 – 30	No gauge	210	R37341-400
1/2"	0 – 60	No gauge	210	R37341-200
1/2"	0 – 140	No gauge	210	R37341-100
1/2"	0 – 140	Flush-mount gauge	210	R37341-600
1/2"	10 – 200	No gauge	210	R37341-300
3/4"	0 – 30	No gauge	210	R37351-400
3/4"	0 – 60	No gauge	210	R37351-200
3/4"	0 – 140	No gauge	210	R37351-100
3/4"	0 – 140	Flush-mount gauge	210	R37351-600
3/4"	10 – 200	No gauge	210	R37351-300
<b>NON-RELIEVING • STANDARD KNOB CONTROL</b>				
3/8"	0 – 30	No gauge	179	R37331-420
3/8"	0 – 60	No gauge	179	R37331-220
3/8"	0 – 140	No gauge	179	R37331-120
3/8"	0 – 140	Flush-mount gauge	179	R37331-620
3/8"	10 – 200	No gauge	179	R37331-320
1/2"	0 – 30	No gauge	210	R37341-420
1/2"	0 – 60	No gauge	210	R37341-220
1/2"	0 – 140	No gauge	210	R37341-120
1/2"	0 – 140	Flush-mount gauge	210	R37341-620
1/2"	10 – 200	No gauge	210	R37341-320
3/4"	0 – 140	Flush-mount gauge	210	R37351-620
3/4"	10 – 200	No gauge	210	R37351-320

## 3000 Series

NPT	Pressure Range psi	Gauge	cfm*	Model
<b>RELIEVING • STANDARD KNOB CONTROL</b>				
3/4"	0 – 30	No gauge	290	R37451-400
3/4"	0 – 60	No gauge	290	R37451-200
3/4"	0 – 140	No gauge	290	R37451-100
3/4"	0 – 140	Flush-mount gauge	290	R37451-600
3/4"	10 – 200	No gauge	290	R37451-300
1"	0 – 30	No gauge	290	R37461-400
1"	0 – 60	No gauge	290	R37461-200
1"	0 – 140	No gauge	290	R37461-100
1"	0 – 140	Flush-mount gauge	290	R37461-600
1"	10 – 200	No gauge	290	R37461-300
<b>NON-RELIEVING • STANDARD KNOB CONTROL</b>				
3/4"	0 – 30	No gauge	290	R37451-420
3/4"	0 – 60	No gauge	290	R37451-220
3/4"	0 – 140	No gauge	290	R37451-120
3/4"	0 – 140	Flush-mount gauge	290	R37451-620
3/4"	10 – 200	No gauge	290	R37451-320
1"	0 – 30	No gauge	290	R37461-420
1"	0 – 60	No gauge	290	R37461-220
1"	0 – 140	No gauge	290	R37461-120
1"	0 – 140	Flush-mount gauge	290	R37461-620
1"	10 – 200	No gauge	290	R37461-320

\*Inlet pressure 100 psi (6.9 bar), 90 psi (6.2 bar), with 33 psi (2.3 bar) drop.

For further model options, port sizes, and information regarding flow charts, unit dimensions, replacement parts, and more, go to:

[ingersollrandproducts.com/accessories](http://ingersollrandproducts.com/accessories)

# Lubricators

1000, 1500, 2000, & 3000 Series

1/8" • 1/4" • 3/8" • 1/2" • 3/4" • 1" Ports

ARO-Flo mist-type lubricators help ensure that pneumatic devices receive the required lubrication to maintain peak performance, reduce wear, and prolong service life. They are designed to provide the correct amount of oil for most general applications in a pneumatic system, delivering a constant ratio of oil to airflow. Precise oil feed adjustment sets the proper oil drip rate. Lubricators should be installed close to the downstream application to ensure effective distribution of oil.



### Technical Data

		SERIES			
		1000	1500	2000	3000
Lubricator body	Aluminum	•	•	•	•
Lubricator sight dome	Nylon	•	•	•	•
Lubricator inlet tube	Urethane	•	•	•	•
Seals	Nitrile	•	•	•	•

SERIES	POLYCARBONATE BOWL	METAL BOWL / METAL BOWL W/ SIGHT GLASS
<b>Max Inlet Pressure (psi)</b>		
1000	150	250
1500	150	250
2000	150	250
3000	–	250
<b>Temperature Range (°F)</b>		
1000	23 – 125	23 – 175
1500	23 – 125	23 – 175
2000	23 – 125	23 – 175
3000	–	23 – 175

## 1000 Series

Adjustment Option	Bowl Cap	Fill Option	Model
oz	cfm*		
<b>METAL BOWLS</b>			
Standard	0.7	Standard	32 L36111-120
Standard	0.7	Standard	51 L36121-120
<b>POLYCARBONATE BOWLS W/ GUARD</b>			
Standard	0.6	Standard	32 L36111-100
Standard	0.6	Standard	51 L36121-100

## 1500 Series

Adjustment Option	Bowl Cap	Fill Option	Model
oz	cfm*		
<b>METAL BOWLS</b>			
Standard	1.5	Standard	51 L36221-120
Standard	1.5	Standard	105 L36231-120
<b>METAL BOWLS W/ SIGHT GLASS</b>			
Standard	1.5	Standard	51 L36221-110
Standard	1.5	Standard	105 L36231-110
<b>POLYCARBONATE BOWLS W/ GUARD</b>			
Standard	1.9	Standard	51 L36221-100
Standard	1.9	Standard	105 L36231-100

## 2000 Series

Adjustment Option	Bowl Cap	Fill Option	Model
oz	cfm*		
<b>METAL BOWLS</b>			
Standard	3.7	Standard	85 L36331-120
Standard	3.7	Standard	156 L36341-120
Standard	3.7	Standard	222 L36351-120
<b>METAL BOWLS W/ SIGHT GLASS</b>			
Standard	3.7	Standard	85 L36331-110
Standard	3.7	Standard	156 L36341-110
Standard	3.7	Standard	222 L36351-110
<b>POLYCARBONATE BOWLS W/ GUARD</b>			
Standard	4.3	Standard	85 L36331-100
Standard	4.3	Standard	156 L36341-100
Standard	4.3	Standard	222 L36351-100

## 3000 Series

Adjustment Option	Bowl Cap	Fill Option	Model
oz	cfm*		
<b>METAL BOWLS</b>			
Standard	3.7	Standard	368 L36451-120
Standard	3.7	Standard	328 L36461-120
<b>METAL BOWLS W/ SIGHT GLASS</b>			
Standard	3.7	Standard	368 L36451-110
Standard	3.7	Standard	328 L36461-110

\*Inlet pressure 90 psi (6.2 bar) with 7 psi (0.5 bar) drop.

For further model options, port sizes, and information regarding flow charts, unit dimensions, replacement parts, and more, go to:

[ingersollrandproducts.com/accessories](http://ingersollrandproducts.com/accessories)



# Piggyback Filters & Regulators

1000, 1500, 2000, & 3000 Series

1/8" • 1/4" • 3/8" • 1/2" • 3/4" • 1" Ports

Filter-regulators, or "piggybacks," combine the functions of both a filter and regulator. Piggybacks are compact and most effective when space is constrained. Piggybacks can be ordered with different filter elements and can be modified with different springs, depending on the filtration and air regulating requirements.



Adjustment range can exceed spring rating on 0 – 30 psi and 0 – 60 psi regulators. The working range of the adjustment knob is designed to permit outlet pressures beyond the spring ratings in the 0 – 30 psi and 0 – 60 psi models. The adjustment knob is not designed to be a pressure limiting device. Limiting devices may be obtained only by special design. For optimal performance, regulators should not be set to ranges outside the specified spring range.

### Technical Data

	SERIES				
	1000	1500	2000	3000	
Spring range options (psi)	0 – 30	•	•	•	•
	0 – 60	•	•	•	•
	0 – 140	•	•	•	–
	0 – 200	–	–	•	•
	10 – 175	–	–	–	•

SERIES	POLYCARBONATE BOWL	METAL BOWL / METAL BOWL W/ SIGHT GLASS
<b>Max Inlet Pressure (psi)</b>		
1000	150	250
1500	150	250
2000	150	250
3000	–	250
<b>Temperature Range (°F)</b>		
1000	23 – 125	23 – 175
1500	23 – 125	23 – 175
2000	23 – 125	23 – 175
3000	–	23 – 175

## 1000 Series

Port	Drain Type	Bowl Cap	Spring Range	w/ Gauge	cfm*	Model
NPT		oz	psi			
<b>5 MICRON • POLYCARBONATE BOWLS • RELIEVING</b>						
1/8"	Manual	0.5	0 – 140	No	43	P39114-100
1/8"	Manual	0.5	0 – 60	No	43	P39114-200
1/8"	Manual	0.5	0 – 30	No	43	P39114-400
1/8"	Manual	0.5	0 – 140	Yes	43	P39114-600
1/8"	Auto	0.7	0 – 60	No	43	P39114-204
1/4"	Manual	0.5	0 – 140	No	47	P39124-100
1/4"	Manual	0.5	0 – 60	No	47	P39124-200
1/4"	Manual	0.5	0 – 30	No	47	P39124-400
1/4"	Manual	0.5	0 – 140	Yes	47	P39124-600
1/4"	Auto	0.7	0 – 140	No	47	P39124-104
1/4"	Auto	0.7	0 – 60	No	47	P39124-204
1/4"	Auto	0.7	0 – 30	No	47	P39124-404
1/4"	Auto	0.7	0 – 140	Yes	47	P39124-604
<b>5 MICRON • METAL BOWLS • RELIEVING</b>						
1/8"	Auto	0.7	0 – 60	Yes	43	P39114-624
1/4"	Manual	0.4	0 – 140	No	47	P39124-120
1/4"	Manual	0.4	0 – 140	Yes	47	P39124-620
1/4"	Auto	0.7	0 – 140	No	47	P39124-124

## 1500 Series

Port	Drain Type	Bowl Cap	Spring Range	w/ Gauge	cfm*	Model
NPT		oz	psi			
<b>5 MICRON • POLYCARBONATE BOWLS • RELIEVING</b>						
1/4"	Manual	1.3	0 – 140	No	72	P39224-100
1/4"	Manual	1.3	0 – 140	Yes	72	P39224-600
1/4"	Auto	1.0	0 – 140	No	72	P39224-104
1/4"	Auto	1.0	0 – 140	Yes	72	P39224-604
3/8"	Manual	1.3	0 – 140	No	90	P39234-100
3/8"	Manual	1.3	0 – 140	Yes	90	P39234-600
3/8"	Auto	1.0	0 – 140	No	90	P39234-104
3/8"	Auto	1.0	0 – 140	Yes	90	P39234-604
<b>5 MICRON • METAL BOWLS W/ SIGHT GLASS • RELIEVING</b>						
1/4"	Manual	1.3	0 – 140	No	72	P39224-110
1/4"	Manual	1.3	0 – 60	No	72	P39224-210
1/4"	Manual	1.3	0 – 140	Yes	72	P39224-610
1/4"	Auto	1.0	0 – 140	No	72	P39224-114
3/8"	Manual	1.3	0 – 140	No	90	P39234-110
3/8"	Manual	1.3	0 – 140	Yes	90	P39234-610
<b>5 MICRON • METAL BOWL • RELIEVING</b>						
1/4"	Manual	1.3	0 – 140	Yes	72	P39224-620

## 2000 Series

Port	Drain Type	Bowl Cap	Spring Range	w/ Gauge	cfm*	Model
NPT		oz	psi			
<b>5 MICRON • POLYCARBONATE BOWLS • RELIEVING</b>						
3/8"	Manual	1.9	0 – 140	No	132	P39334-100
3/8"	Manual	1.9	0 – 140	Yes	132	P39334-600
3/8"	Auto	2.3	0 – 140	No	132	P39334-104
3/8"	Auto	2.3	0 – 140	Yes	132	P39334-604
1/2"	Manual	1.9	0 – 140	No	172	P39344-100
1/2"	Manual	1.9	0 – 140	Yes	172	P39344-600
1/2"	Auto	2.3	0 – 140	No	172	P39334-104
1/2"	Auto	2.3	0 – 140	Yes	172	P39334-604
3/4"	Manual	1.9	0 – 140	No	173	P39354-100
3/4"	Manual	1.9	0 – 140	Yes	173	P39354-600
<b>5 MICRON • METAL BOWLS W/ SIGHT GLASS • RELIEVING</b>						
3/8"	Manual	2.4	0 – 140	No	132	P39334-110
3/8"	Manual	2.4	0 – 140	Yes	132	P39334-610
3/8"	Auto	2.8	0 – 140	No	132	P39334-114
3/8"	Auto	2.8	0 – 140	Yes	132	P39334-614
1/2"	Manual	2.4	0 – 140	No	172	P39344-110
1/2"	Manual	2.4	0 – 140	Yes	172	P39344-610
1/2"	Auto	2.8	0 – 140	No	172	P39344-114
1/2"	Auto	2.8	0 – 140	Yes	172	P39344-614
3/4"	Manual	2.4	0 – 140	No	173	P39354-110
3/4"	Manual	2.4	0 – 140	Yes	173	P39354-610

## 3000 Series

Port	Drain Type	Bowl Cap	Spring Range	w/ Gauge	cfm*	Model
NPT		oz	psi			
<b>5 MICRON • METAL BOWLS W/ SIGHT GLASS • RELIEVING</b>						
3/4"	Manual	5.3	0 – 140	Yes	236	P39454-610
3/4"	Auto	5.9	0 – 140	Yes	236	P39454-614
1"	Manual	5.3	0 – 140	Yes	250	P39464-610
1"	Auto	5.9	0 – 140	Yes	250	P39464-614

\*Inlet pressure 100 psi (6.9 bar), 90 psi (6.2 bar), with 33 psi (2.3 bar) drop.

For further model options, port sizes, and information regarding flow charts, unit dimensions, replacement parts, and more, go to:

[ingersollrandproducts.com/accessories](http://ingersollrandproducts.com/accessories)

## 2-Piece Combinations

1000, 1500, 2000, & 3000 Series

1/8" • 1/4" • 3/8" • 1/2" • 3/4" • 1" Ports

Filters, regulators, lubricators, and piggybacks can be combined together to form combinations. They are typically strung together in the F+R+L arrangement (three-piece combo) and F/R+L (two-piece combo) arrangement, although other configurations are also used depending on application needs. ARO-Flo combination FRLs are easily assembled using modular spacer kits.



### Technical Data

	SERIES			
	1000	1500	2000	3000
<b>Spring range options (psi)</b>	0 – 140	0 – 140	0 – 140	–
	–	–	–	0 – 200
<b>Filter element</b>	5 micron			
<b>Filter bowl cap – manual drain (oz)</b>	POLYCARBONATE BOWL			
	0.5	1.3	1.9	–
	METAL BOWL			
	0.4	–	–	–
<b>Filter bowl cap – auto drain (oz)</b>	POLYCARBONATE BOWL			
	–	1.3	2.4	5.3
	METAL BOWL			
	0.7	–	–	–
<b>Lubricator bowl capacity</b>	POLYCARBONATE BOWL			
	0.6	1.9	4.3	–
	METAL BOWL			
	0.7	–	–	–
	METAL / METAL BOWL W/ SIGHT GLASS			
	–	1.0	2.8	5.9
	METAL / METAL BOWL W/ SIGHT GLASS			
	–	1.5	3.7	3.2

SERIES	POLYCARBONATE BOWL	METAL BOWL / METAL BOWL W/ SIGHT GLASS
<b>Max Inlet Pressure (psi)</b>		
1000	150	250
1500	150	250
2000	150	250
3000	–	250
<b>Temperature Range (°F)</b>		
1000	23 – 125	23 – 175
1500	23 – 125	23 – 175
2000	23 – 125	23 – 175
3000	–	23 – 175

### 1000 Series

NPT	Components		cfm*	Model
	Filter-Regulator	Lubricator		
<b>MANUAL DRAIN • METAL BOWLS • RELIEVING • W/ GAUGE</b>				
1/8"	P39114-620	L36111-120	36	C38111-620
1/4"	P39124-620	L36121-120	44	C38121-620
<b>MANUAL DRAIN • POLYCARBONATE BOWLS • RELIEVING • W/ GAUGE</b>				
1/8"	P39114-600	L36111-100	36	C38111-600
1/4"	P39124-600	L36121-100	44	C38121-600
<b>AUTO DRAIN • METAL BOWL • RELIEVING • W/ GAUGE</b>				
1/4"	P39124-624	L36121-120	44	C38121-621
<b>AUTO DRAIN • POLYCARBONATE BOWL • RELIEVING • W/ GAUGE</b>				
1/4"	P39124-604	L36121-100	44	C38121-601

### 1500 Series

NPT	Components		cfm*	Model
	Filter-Regulator	Lubricator		
<b>MANUAL DRAIN • METAL BOWLS W/ SIGHT GLASS • RELIEVING • W/ GAUGE</b>				
1/4"	P39224-610	L36221-110	58	C38221-610
3/8"	P39234-610	L36231-110	71	C38231-610
<b>MANUAL DRAIN • POLYCARBONATE BOWLS W/ GUARD • RELIEVING • W/ GAUGE</b>				
1/4"	P39224-600	L36221-100	58	C38221-600
3/8"	P39234-600	L36231-100	71	C38231-600
<b>AUTO DRAIN • METAL BOWLS W/ SIGHT GLASS • RELIEVING • W/ GAUGE</b>				
1/4"	P39224-614	L36221-110	58	C38221-611
3/8"	P39234-614	L36231-110	71	C38231-611
<b>AUTO DRAIN • POLYCARBONATE BOWLS W/ GUARD • RELIEVING • W/ GAUGE</b>				
1/4"	P39224-604	L36221-100	58	C38221-601
3/8"	P39234-604	L36231-100	71	C38231-601

### 2000 Series

NPT	Components		cfm*	Model
	Filter-Regulator	Lubricator		
<b>MANUAL DRAIN • METAL BOWLS W/ SIGHT GLASS • RELIEVING • W/ GAUGE</b>				
3/8"	P39334-610	L36331-110	96	C38331-610
1/2"	P39344-610	L36341-110	120	C38341-610
3/4"	P39354-610	L36351-110	142	C38351-610
<b>MANUAL DRAIN • POLYCARBONATE BOWLS W/ GUARD • RELIEVING • W/ GAUGE</b>				
3/8"	P39334-600	L36331-100	96	C38331-600
1/2"	P39344-600	L36341-100	120	C38341-600
3/4"	P39354-600	L36351-100	142	C38351-600
<b>AUTO DRAIN • METAL BOWLS W/ SIGHT GLASS • RELIEVING • W/ GAUGE</b>				
3/8"	P39334-614	L36331-110	96	C38331-611
1/2"	P39344-614	L36341-110	120	C38341-611
3/4"	P39354-614	L36351-110	142	C38351-611
<b>AUTO DRAIN • POLYCARBONATE BOWLS W/ GUARD • RELIEVING • W/ GAUGE</b>				
3/8"	P39334-604	L36331-100	96	C38331-601
1/2"	P39344-604	L36341-100	120	C38341-601
3/4"	P39354-604	L36351-100	142	C38351-601

### 3000 Series

NPT	Components		cfm*	Model
	Filter-Regulator	Lubricator		
<b>MANUAL DRAIN • METAL BOWLS W/ SIGHT GLASS • RELIEVING • W/ GAUGE</b>				
3/4"	P39454-610	L36451-110	201	C38451-610
1"	P39464-610	L36461-110	208	C38461-610
<b>AUTO DRAIN • METAL BOWLS W/ SIGHT GLASS • RELIEVING • W/ GAUGE</b>				
3/4"	P39454-614	L36451-110	201	C38451-611
1"	P39464-614	L36461-110	208	C38461-611

**Note:** Other combinations may be assembled by purchasing the individual components separately. Modular connector kits are required to connect the individual units together.

\*Inlet pressure 100 psi (6.9 bar), 90 psi (6.2 bar), with 33 psi (2.3 bar) drop.

For further model options, port sizes, and information regarding flow charts, unit dimensions, replacement parts, and more, go to:

[ingersollrandproducts.com/accessories](http://ingersollrandproducts.com/accessories)



# 3-Piece Combinations

1000, 1500, 2000, & 3000 Series

1/8" • 1/4" • 3/8" • 1/2" • 3/4" • 1" Ports



Filters, regulators, lubricators, and piggybacks can be combined together to form combinations. They are typically strung together in the F+R+L arrangement (three-piece combo) and F/R+L (two-piece combo) arrangement, although other configurations are also used depending on application needs. ARO-Flo combination FRLs are easily assembled using modular spacer kits.

### Technical Data

	SERIES			
	1000	1500	2000	3000
<b>Spring range options (psi)</b>	0 - 140	0 - 140	0 - 140	-
	-	-	-	0 - 200
<b>Filter element</b>	5 micron			
<b>Filter bowl cap - manual drain (oz)</b>	POLYCARBONATE BOWL			
	0.5	1.3	1.9	-
	METAL BOWL			
	0.4	-	-	-
<b>Filter bowl cap - auto drain (oz)</b>	METAL / METAL BOWL W/ SIGHT GLASS			
	-	1.3	2.4	5.3
	POLYCARBONATE BOWL			
	0.7	1.0	2.3	-
<b>Lubricator bowl capacity</b>	METAL BOWL			
	0.7	-	-	-
	METAL / METAL BOWL W/ SIGHT GLASS			
	-	1.0	2.8	5.9
<b>Lubricator bowl capacity</b>	POLYCARBONATE BOWL			
	0.6	1.9	4.3	-
	METAL BOWL			
	-	1.5	3.7	3.2

SERIES	POLYCARBONATE BOWL	METAL BOWL / METAL BOWL W/ SIGHT GLASS
<b>Max Inlet Pressure (psi)</b>		
1000	150	250
1500	150	250
2000	150	250
3000	-	250
<b>Temperature Range (°F)</b>		
1000	23 - 125	23 - 175
1500	23 - 125	23 - 175
2000	23 - 125	23 - 175
3000	-	23 - 175

## 1000 Series

NPT	Filter	Components		Lubricator	cfm*	Model
		Regulator	Lubricator			
<b>MANUAL DRAIN • METAL BOWLS • RELIEVING • W/ GAUGE</b>						
1/8"	F35111-420	R37111-600	L36111-120	34	C38111-820	
1/4"	F35121-420	R37121-600	L36121-120	46	C38121-820	
<b>MANUAL DRAIN • POLYCARBONATE BOWLS • RELIEVING • W/ GAUGE</b>						
1/8"	F35111-400	R37111-600	L36111-100	34	C38111-800	
1/4"	F35121-400	R37121-600	L36121-100	46	C38121-800	
<b>AUTO DRAIN • METAL BOWL • RELIEVING • W/ GAUGE</b>						
1/4"	F35121-421	R37121-600	L36121-120	46	C38121-821	
<b>AUTO DRAIN • POLYCARBONATE BOWL • RELIEVING • W/ GAUGE</b>						
1/4"	F35121-401	R37121-600	L36121-100	46	C38121-801	

## 1500 Series

NPT	Filter	Components		Lubricator	cfm*	Model
		Regulator	Lubricator			
<b>MANUAL DRAIN • METAL BOWLS W/ SIGHT GLASS • RELIEVING • W/ GAUGE</b>						
1/4"	F35221-410	R37221-600	L36221-110	61	C38221-810	
3/8"	F35231-410	R37231-600	L36231-110	85	C38231-810	
<b>MANUAL DRAIN • POLYCARBONATE BOWLS W/ GUARD • RELIEVING • W/ GAUGE</b>						
1/4"	F35221-400	R37221-600	L36221-100	61	C38221-800	
3/8"	F35231-400	R37231-600	L36231-100	85	C38231-800	
<b>AUTO DRAIN • METAL BOWLS W/ SIGHT GLASS • RELIEVING • W/ GAUGE</b>						
1/4"	F35221-411	R37221-600	L36221-110	61	C38221-811	
3/8"	F35231-411	R37231-600	L36231-110	85	C38231-811	
<b>AUTO DRAIN • POLYCARBONATE BOWLS W/ GUARD • RELIEVING • W/ GAUGE</b>						
1/4"	F35221-401	R37221-600	L36221-100	61	C38221-801	
3/8"	F35231-401	R37231-600	L36231-100	85	C38231-801	

## 2000 Series

NPT	Filter	Components		Lubricator	cfm*	Model
		Regulator	Lubricator			
<b>MANUAL DRAIN • METAL BOWLS W/ SIGHT GLASS • RELIEVING • W/ GAUGE</b>						
3/8"	F35331-410	R37331-600	L36331-110	99	C38331-810	
1/2"	F35341-410	R37341-600	L36341-110	150	C38341-810	
3/4"	F35351-410	R37351-600	L36351-110	171	C38351-810	
<b>MANUAL DRAIN • POLYCARBONATE BOWLS W/ GUARD • RELIEVING • W/ GAUGE</b>						
3/8"	F35331-400	R37331-600	L36331-100	99	C38331-800	
1/2"	F35341-400	R37341-600	L36341-100	150	C38341-800	
3/4"	F35351-400	R37351-600	L36351-100	171	C38351-800	
<b>AUTO DRAIN • METAL BOWLS W/ SIGHT GLASS • RELIEVING • W/ GAUGE</b>						
3/8"	F35331-411	R37331-600	L36331-110	99	C38331-811	
1/2"	F35341-411	R37341-600	L36341-110	150	C38341-811	
3/4"	F35351-411	R37351-600	L36351-110	171	C38351-811	
<b>AUTO DRAIN • POLYCARBONATE BOWLS W/ GUARD • RELIEVING • W/ GAUGE</b>						
3/8"	F35331-401	R37331-600	L36331-100	99	C38331-801	
1/2"	F35341-401	R37341-600	L36341-100	150	C38341-801	
3/4"	F35351-401	R37351-600	L36351-100	171	C38351-801	

## 3000 Series

NPT	Filter	Components		Lubricator	cfm*	Model
		Regulator	Lubricator			
<b>MANUAL DRAIN • METAL BOWLS W/ SIGHT GLASS • RELIEVING • W/ GAUGE</b>						
3/4"	F35451-410	R37451-600	L36451-110	199	C38451-810	
1"	F35461-410	R37461-600	L36461-110	215	C38461-810	
<b>AUTO DRAIN • METAL BOWLS W/ SIGHT GLASS • RELIEVING • W/ GAUGE</b>						
3/4"	F35451-411	R37451-600	L36451-110	199	C38451-811	
1"	F35461-411	R37461-600	L36461-110	215	C38461-811	

**Note:** Other combinations may be assembled by purchasing the individual components separately. Modular connector kits are required to connect the individual units together.

\*Inlet pressure 100 psi (6.9 bar), 90 psi (6.2 bar), with 33 psi (2.3 bar) drop.

For further model options, port sizes, and information regarding flow charts, unit dimensions, replacement parts, and more, go to:

[ingersollrandproducts.com/accessories](http://ingersollrandproducts.com/accessories)

## Inline Series Lubricators

1/4" • 3/8" • 1/2" • 3/4" Ports

Inline lubricators ensure proper lubrication for small pneumatic hand tools. These inline lubricators put the oil source right at the tool. Oil capacity is 1/4 oz. (1 ml); enough to last through an average eight-hour shift. This lubricator requires cyclical or intermittent airflow for proper operation, and consequently works best when installed at the tool inlet or on a short hose near the tool.

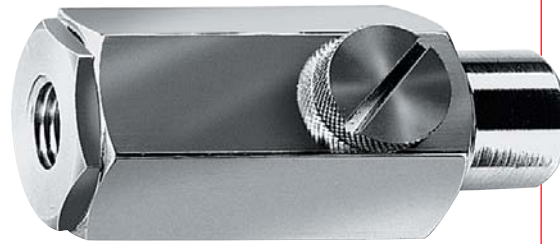

### Technical Data

Flow capacity*	1/4" — 36.0 cfm (17.0 dm <sup>3</sup> /s)
Flow capacity*	3/8" — 38.1 cfm (18.0 dm <sup>3</sup> /s)
Operating temperature	32° – 150° F (0° – 65.5° C)
Max supply pressure	200 psig (13.8 bar)
Useful retention**	0.25 oz (7.4 cm <sup>3</sup> )
Port size	NPT / BSPT-Rc — 1/4", 3/8"
Weight	0.2 lb (0.1 kg)

\*Inlet pressure of 150 psig (10.3 bar). Pressure drop of 5 psid (0.3 bar).  
\*\*Useful retention refers to usable volume.

NPT	cfm*	Bowl Size oz	lb	Model
<b>INLINE LUBRICATORS</b>				
1/4"	36	0.25	0.2	L01-02-000
3/8"	38.1	0.25	0.2	L01-03-000
3/4"	45	5	1.5	6LUB12
3/4"	80	8	2	8LUB12

**Note:** The L01 cannot be filled under pressure.

## Liquidator™ Filters

1/4" • 3/8" • 1/2" • 3/4" Ports

You can depend on Ingersoll Rand Liquidator™ filters to deliver clean, dry air to all of your operations. Liquidator filters are designed to extract large volumes of liquid contaminants, foreign particles, and condensation in air lines. They are ideal for critical applications in paint and body shops, food processing and packaging, hospital and dental equipment, process controls, printing plants, electronics clean rooms, sandblasting, and air tool operations.

### Stacked Liquidators — Solutions to Air Line Contaminants

- Air quality safe enough for your most demanding applications.
- Instrument air quality as clean as 0.01 micron.
- Air-logic dew point suppressed desiccant dryer system without the hassles.

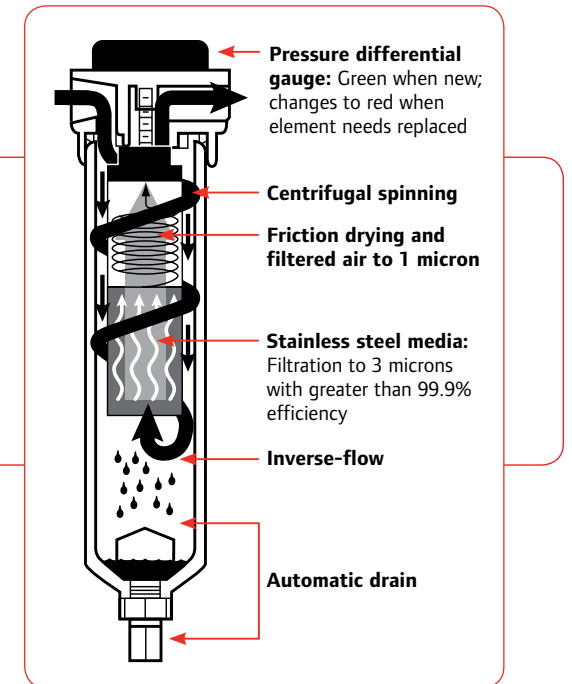

Model	NPT	Description	cfm
<b>STACKED LIQUIDATORS W/ POLYCARBONATE BOWLS</b>			
8842-W1-020	1/4"	Stacked Liquidator, indicator, & automatic drain	20
8842-W1-035	1/4"	Stacked Liquidator, indicator, & automatic drain	35
8843-W1-035	3/8"	Stacked Liquidator, indicator, & automatic drain	35
8844-W1-035	1/2"	Stacked Liquidator, indicator, & automatic drain	35
8844-W1-060	1/2"	Stacked Liquidator, indicator, & automatic drain	60
8844-W1-090	1/2"	Stacked Liquidator, indicator, & automatic drain	90
8846-W1-090	3/4"	Stacked Liquidator, indicator, & automatic drain	90
8848-W1-150	1"	Stacked Liquidator, indicator, & automatic drain	150
<b>STACKED LIQUIDATORS W/ METAL BOWLS</b>			
8844-W1-M60	1/2"	Stacked Liquidator, indicator, & automatic drain	60
8846-W1-M90	3/4"	Stacked Liquidator, indicator, & automatic drain	90
8848-W1-M150	1"	Stacked Liquidator, indicator, & automatic drain	150
8830-W1-000	1-1/4"	Stacked Liquidator & automatic drain	400
8852-W1-M300	1-1/2"	Stacked Liquidator, indicator, & automatic drain	300
8832-W1-000	1-1/2"	Stacked Liquidator & automatic drain	400
8854-W1-M300	2"	Stacked Liquidator, indicator, & automatic drain	300
8834-W1-000	2"	Stacked Liquidator & automatic drain	700
<b>SIDE-BY-SIDE LIQUIDATORS</b>			
8828-W2-000	1"	Side-by-side Liquidators, polycarbonate bowl, & automatic drain	175
8828-W2-M00	1"	Side-by-side Liquidators, metal bowl, & automatic drain	175
<b>ASA FLANGE LIQUIDATORS</b>			
8836-W1-M2500	3" ASA	Flanged main line separator filter	2,500
8848-W1-M2500	4" ASA	Flanged main line separator filter	2,500
8860-W1-M5500	6" ASA	Flanged main line separator filter	5,500

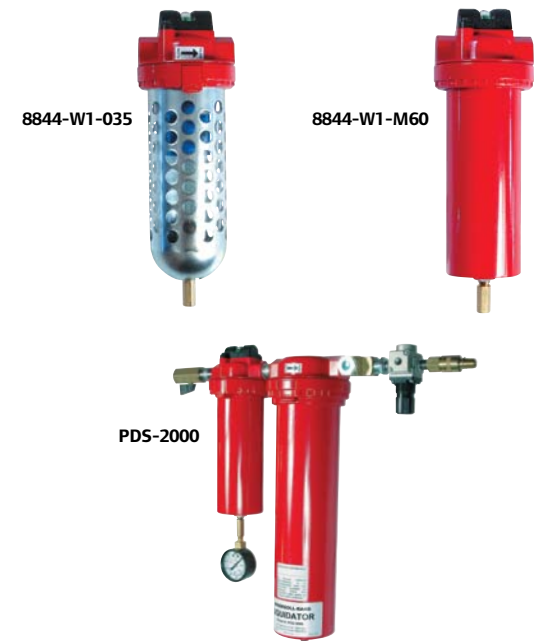

Model	NPT	Description	cfm
<b>DESICCANT DRYERS &amp; PREP STATION</b>			
PDS-2000	1/2"	Paint booth desiccant dryer system with 1/4" regulator and gauge	25
EAD-6000	1/2"	Prep station air dryer with 1/4" regulator and gauge	60

For further model options, port sizes, and information regarding flow charts, unit dimensions, replacement parts, and more, go to:

[ingersollrandproducts.com/accessories](http://ingersollrandproducts.com/accessories)



## Accessories

### Modular threaded lockout valve



Meets OSHA regulation 1910.147. This valve provides a safety lockout to prevent accidental machine start-up. When the slider is shifted into the lockout position, inlet air is blocked and downstream air is exhausted to atmosphere. The slider contains a hole that enables the user to attach a lock to the unit, preventing accidental shifting. The lockout valve is modular and can be connected via the modular clamp spacers, or threaded pipe. Order modular clamps separately.

Model Number	Size	Material	Port Size	Description
104390-1	1000 Series	Body: aluminum  Lockout switch: acetal	1/8" - NPT	Lockout valve
104390-2			1/4" - NPT	
104390-A			1/8" - BSP	
104390-B			1/4" - BSP	
104391-2	1500 Series		1/4" - NPT	
104391-3			3/8" - NPT	
104391-B			1/4" - BSP	
104391-C	2000 Series		3/8" - BSP	
104392-3		3/8" - NPT		
104392-4		1/2" - NPT		
104392-C		3/8" - BSP		
104392-D	3000 Series	1/2" - BSP		
104393-5		3/4" - NPT		
104393-6		1" - NPT		
104393-E	3000 Series	3/4" - BSP		
104393-F		1" - BSP		

### Modular check valve



The modular check valve is used to prevent downstream pressure loss. Acting as a one-way directional flow valve, this device is generally installed downstream of the regulator. The modular check valve is connected via modular clamps. Order modular clamps separately.

Model Number	Size	Material	Port Size	Top Port (NPT)	Description
104477-1	1000 Series	Body: aluminum  Seals: nitrile	1/4"	1/8"	Check valve
104477-2			1/4"	1/4"	
104478-1	1500 Series		3/8"	1/8"	
104478-2			3/8"	1/4"	
104479-2	2000 Series		1/2"	1/4"	
104479-3			1/2"	3/8"	

### Soft start valve



Machine system start-up and the related air surge can both damage and reduce the operating efficiency of its pneumatic components. Over time, the air surge on components takes an even heavier toll on the machine's overall productivity and on your maintenance schedule. The ARO Soft-Start Valve eliminates the surge at start-up to help protect your system.

Model Number	Description
SSV343-024-D	1/2" NPT, 24 DC
SSV343-120-A	1/2" NPT, 120 AC
SSV3D3-024-D	1/2" BSP, 24 DC
SSV3D3-120-A	1/2" BSP, 120 AC

Technical Data			
Size	2000 Series, 1/2" port size	Voltage allowance	-15% ~ +10%
Operating pressure range	44 - 130 psi (3 - 9 bar)	Power consumption (AC) inrush	5.6 VA (50 Hz), 5.0 VA (60 Hz)
Gauge port	1/8"	Power consumption (AC) holding	3.3 VA (50 Hz), 2.3 VA (60 Hz)
Max fluid and ambient temperature	122°F (50°C)	Power consumption (DC)	1.8 W / 2 W (with lamp)
Effective orifice size	P->A = .098 in <sup>2</sup> (63 mm <sup>2</sup> ), A->R = .068 in <sup>2</sup> (44 mm <sup>2</sup> )	Electrical connection	Din connector
Voltage options	120 AC, 24 DC	Manual override	Locking

### Pressure switch



The use of a pressure switch allows for the sensing of high- or low-pressure thresholds. The switch is designed to be used with the modular manifold block. The pressure switch is offered in 1/8" NPT.

Model Number	Port Size	Material	Description
104415	1/8"	Bracket: zinc O-ring: nitrile Body: nylon	Pressure switch

### T-bracket



T-brackets provide an excellent solution for wall-mounting your FRL unit. They can be used for single or combination configurations in the modular arrangement. T-type brackets give good wall-to-unit clearance for installing fittings or other connections. Kit includes bracket, modular clamp, and bolt(s).

Model Number	Size	Material	Description
104399	1000 Series	Nylon	T-type wall mounts
104400	1500 Series	Nylon	
104401	2000 Series	Aluminum	
104402	3000 Series	Aluminum	

### Modular clamp & spacer kit



Modular clamps are used to connect any two modular FRL units or accessories together. The kit includes both a front and a back clamp, along with the connecting bolt(s). The steel bolts are metric hex head.

Model Number	Size	Material	Description
104394	1000 Series	Nylon	Modular / clamp spacer kit
104395	1500 Series	Aluminum	
104396	2000 Series	Aluminum & zinc	
104397	3000 Series	Aluminum	

### Panel nut



The panel nut allows the user to attach the regulator or piggyback unit to a panel or L-bracket. Panel nuts are included as standard on all ARO-Flo Series regulators and piggybacks.

Model Number	Size	Material	Description
104416	1000 Series	Nylon	Panel nut
104417	1500 Series		
104418	2000 Series		
104419	3000 Series		

### C-bracket



C-brackets are designed to hold either a single filter or single lubricator unit. The bracket has two holes to allow for the unit to be bolted to a wall or other flat surface. Mounting hardware not included.

Model Number	Size	Material	Description
104407	1000 Series	Steel	C-type wall bracket
104408	1500 Series		
104409*	2000 Series		
104410	3000 Series		

\*Does not fit 3/4" NPT filter

### L-bracket



L-brackets are designed to allow the user to mount a regulator or piggyback unit to a wall or flat surface. A panel nut should be used to keep the unit in place. Panel nuts are included as standard equipment on all ARO-Flo regulators and piggybacks, and replacements can be ordered separately.

Model Number	Size	Material	Description
104403	1000 Series	Steel	L-type wall bracket
104404	1500 Series		
104405	2000 Series		
104406	3000 Series		

For further model options, port sizes, and information regarding flow charts, unit dimensions, replacement parts, and more, go to:

[ingersollrandproducts.com/accessories](http://ingersollrandproducts.com/accessories)

## Accessories

### Modular threaded pipe adapter



Pipe adapter blocks allow single or multiple units to be plumbed to an air system in the modular arrangement. They allow for ease of service when removing a unit from the line, and can also allow for different pipe diameters to be used in the plumbing setup. Kit includes two pipe adapters. Order modular clamps separately.

Model Number	Size	Material	Port Size	Description
104474-1	1000 Series	Body: aluminum	1/8" – NPT	Modular (threaded) pipe adapter
104474-2			1/4" – NPT	
104474-A			1/8" – BSP	
104474-B			1/4" – BSP	
104475-2	1500 Series		1/4" – NPT	
104475-3			3/8" – NPT	
104475-B			1/4" – BSP	
104475-C			3/8" – BSP	
104398-3	2000 Series		3/8" – NPT	
104398-4			1/2" – NPT	
104398-C			3/8" – BSP	
104398-D			1/2" – BSP	
104476-5	3000 Series		3/4" – NPT	
104476-6			1" – NPT	
104476-E			3/4" – BSP	
104476-F			1" – BSP	

### Gauges & port blocks



In the absence of the standard integral gauge, a gauge port block can be used with a screw-in aftermarket gauge. All regulators, piggybacks, and combo units ordered without a gauge will come with a gauge port block supplied as standard. All port blocks are 1/8" NPT.

Model Number	Size	Material	Description
104467	1000 / 1500 Series	Body: nylon Thread: steel Lens: poly	Gauge port block
104469	2000 / 3000 Series		Gauge port block
104310	1000 / 1500 Series		Flush-mount gauge (0 – 140 psi)
104334	2000 / 3000 Series		Flush-mount gauge (0 – 140 psi)

### Modular threaded manifold block kit



Using the modular manifold block is an excellent way to provide circuit design flexibility. Normally installed downstream of the regulator, the manifold block allows clean, regulated air to be sent to signal or other equipment. The manifold blocks are offered in different port configurations to suit different application needs. Use modular clamps to attach to other components or threaded pipe. Order modular clamps separately.

Model Number	Size	Material	Port Size	Description
104411-1-1	1000 Series	Body: aluminum	1/8" x 1/8"	Manifold block kit
104411-2-2			1/4" x 1/4"	
104412-2-1	1500 Series		1/4" x 1/8"	
104412-2-2			1/4" x 1/4"	
104412-3-1			3/8" x 1/8"	
104412-3-2			3/8" x 1/4"	
104413-3-2	2000 Series		3/8" x 1/4"	
104413-3-3			3/8" x 3/8"	
104413-4-2			1/2" x 1/4"	
104413-4-3			1/2" x 3/8"	



### Add-on gauges

Model	Port	Range (psi)	Size	Case	Lens
104491	1/8"	0 – 45	1.5"	Plastic	Polycarbonate
104488	1/8"	0 – 45	1.5"	Steel	Glass
104498	1/8"	0 – 45	2"	Plastic	Polycarbonate
104494	1/8"	0 – 45	2"	Steel	Glass
104492	1/8"	0 – 75	1.5"	Plastic	Polycarbonate
104489	1/8"	0 – 75	1.5"	Steel	Glass
104499	1/8"	0 – 75	2"	Plastic	Polycarbonate
104495	1/8"	0 – 75	2"	Steel	Glass
104493	1/8"	0 – 160	1.5"	Plastic	Polycarbonate
104490	1/8"	0 – 160	1.5"	Steel	Glass
104500	1/8"	0 – 160	2"	Plastic	Polycarbonate
104496	1/8"	0 – 160	2"	Steel	Glass
104504	1/4"	0 – 160	2"	Plastic	Polycarbonate
104502	1/4"	0 – 160	2"	Steel	Glass
104501	1/8"	0 – 250	2"	Plastic	Polycarbonate
104497	1/8"	0 – 250	2"	Steel	Glass
104505	1/4"	0 – 250	2"	Plastic	Polycarbonate
104503	1/4"	0 – 250	2"	Steel	Glass



# Hoses & Fittings

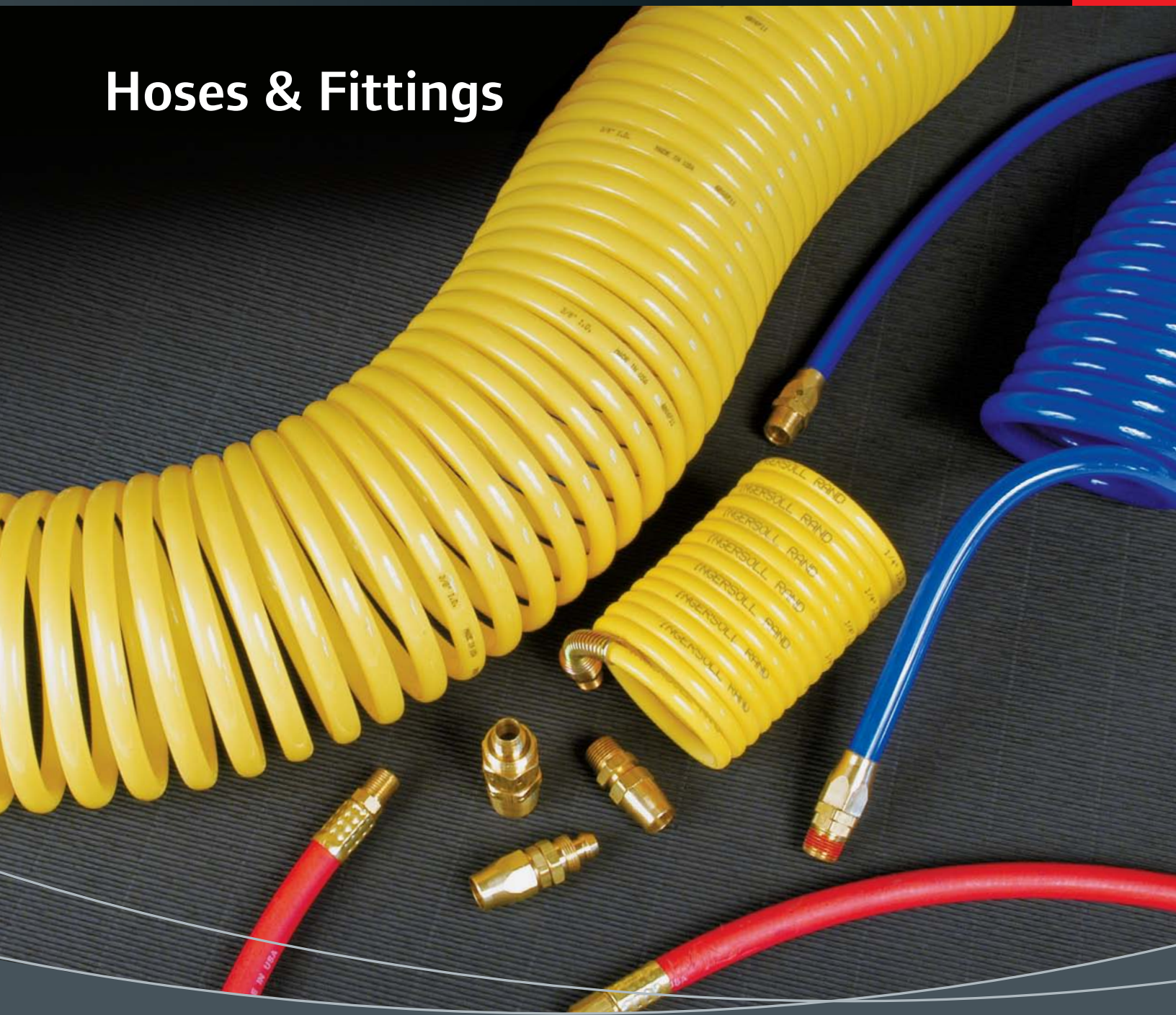

# Hoses and Fittings

Hoses & Fittings



Hoses & Fittings





## Premium Rubber Hose

### Features

- Longer life than PVC
- Reinforced innermost tube, resistant to the materials it is intended to convey
- Extended life bend restricters
- Increased flexibility in cold temperatures
- Designed to withstand the harshest jobsite conditions
- Extended service life due to number of threads, spirals, and thickness of rubber tube





Model	 in	 ft
38016820	3/8"	50'

## Bulk Hose

Model	 in	Description	 psig
50923	1/4"	1 braid rayon	250
BH6C	3/8"	1 braid rayon	250
BH8A	1/2"	1 braid rayon	250
BH12A	3/4"	1 braid rayon	200



## Whip Hoses



Model	 Male NPT	 Female NPT	 in	 ft	 psig
R00H-130	1/8"	1/4"	1/4"	8'	250
R0-130	1/4"	3/8"	5/16"	8'	250
R1A-130	1/4"	3/8"	3/8"	8'	250
510-130	3/8"	3/8"	3/8"	8'	250

## Assembled Construction Tool Hoses







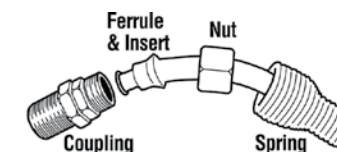

Model	 in	Description	 ft
22040687	1/2"	Double-banded universal to 3/8" NPT straight male	8'
22041453	1/2"	Double-banded universal to 1/2" NPT straight male	8'
22041461	1/2"	Double-banded universal to 1/2" NPT swivel inlet	8'
22041479	1/2"	Double-banded universal to 7/8" - 24" NPT swivel inlet	8'
22040679	3/4"	Double-banded universals on both ends, 300 psi max	50'

## Nylon Recoil Hoses



### Features

- Permanently coiled hoses automatically return to their original position, keeping them off the floor and out of your way as you work
- Made from abrasive-resistant and memory-resilient Nylon II
- For use with air, gases, water, and liquids compatible with Nylon II
- Certified to a maximum pressure of 200 psi
- Fittings and hose ends are protected by spring guards
- Available with diameters of 1/4", 3/8", 1/2", and 3/4"
- Available in bulk lengths of 12', 25', 50', and 100'



Model	 NPT	 in	 in	 in	 ft	 ft
<b>SWIVEL COUPLING AT ONE END</b>						
N14-12A	1/4"	1/4"	3-1/2"	6"	10'	12'
N14-25A	1/4"	1/4"	3-1/2"	10-1/2"	22'	25'
N14-50A	1/4"	1/4"	3-1/2"	21"	45'	50'
N38-12A	3/8"	3/8"	5-5/8"	5"	10'	12'
N38-25A	3/8"	3/8"	5-5/8"	10-1/4"	21'	25'
N38-50A	3/8"	3/8"	5-5/8"	21"	44'	50'
N12-12A	1/2"	1/2"	9"	5"	9'	12'
N12-25A	1/2"	1/2"	9"	9"	18'	25'
N12-50A	1/2"	1/2"	9"	19"	41'	50'
<b>SWIVEL COUPLING AT BOTH ENDS</b>						
N14-12B	1/4"	1/4"	3-1/2"	6"	10'	12'
N14-25B	1/4"	1/4"	3-1/2"	10-1/2"	22'	25'
N14-50B	1/4"	1/4"	3-1/2"	21"	45'	50'
N38-124B	1/4"	3/8"	5-5/8"	5"	10'	12'
N38-254B	1/4"	3/8"	5-5/8"	10-1/4"	21'	25'
N38-504B	1/4"	3/8"	5-5/8"	21"	44'	50'
N38-12B	3/8"	3/8"	5-5/8"	5"	10'	12'
N38-25B	3/8"	3/8"	5-5/8"	10-1/4"	21'	25'
N38-50B	3/8"	3/8"	5-5/8"	21"	44'	50'
N12-12B	1/2"	1/2"	9"	5"	9'	12'
N12-25B	1/2"	1/2"	9"	9"	18'	25'
N12-50B	1/2"	1/2"	9"	18"	41'	50'
N34-12B	3/4"	3/4"	12-1/2"	4-1/2"	10'	12'
N34-25B	3/4"	3/4"	12-1/2"	9"	17'	25'
N34-50B	3/4"	3/4"	12-1/2"	16"	35'	50'
<b>RIGID COUPLING AT BOTH ENDS</b>						
N14-12	1/4"	1/4"	3-1/2"	6"	10'	12'
N14-25	1/4"	1/4"	3-1/2"	10-1/2"	22'	25'
N14-50	1/4"	1/4"	3-1/2"	21"	45'	50'
N38-12	3/8"	3/8"	5-5/8"	5"	10'	12'
N38-25	3/8"	3/8"	5-5/8"	10-1/4"	21'	25'
N38-50	3/8"	3/8"	5-5/8"	21"	44'	50'
N12-12	1/2"	1/2"	9"	5"	9'	12'
N12-25	1/2"	1/2"	9"	9"	18'	25'
N12-50	1/2"	1/2"	9"	18"	41'	50'
<b>BULK HOSES</b>						
N14-100	—	1/4"	3-1/2"	45"	90'	100'
N38-100	—	3/8"	5-5/8"	38"	85'	100'
N12-100	—	1/2"	9"	35"	75'	100'
N34-100	—	3/4"	12-1/2"	29"	70'	100'

### Fittings for Nylon Recoil Hoses\*

 NPT	 in	Rigid Fitting	Swivel Fitting	For Use with Bulk Hose
1/4"	1/4"	RK090	RK092	N14-100
1/4"	3/8"	—	RK114	N38-10
3/8"	3/8"	RK110	RK112	N38-100
1/2"	1/2"	RK118	RK119	N12-100
3/4"	3/4"	—	CSM-1212	N34-100



\*Order two fittings per hose.



## P-Series Polyurethane Coiled Hoses

### Features

- Superior elasticity and coil memory help keep the work environment clean and organized
- Outstanding flexibility increases operator comfort
- 25% lighter than rubber hose, reducing operator fatigue
- Abrasion and kink resistance increase lifetime
- Tight coil diameter allows easy entry into confined spaces
- Non-marring surface won't harm work pieces
- Broad chemical resistance makes hoses suitable for most environments
- Better than 80% working length extends your work space
- Straight tails on both ends eliminate workstation tangles
- Reusable MNPT fittings allow field retrofits
- Thread sealant on all fittings provides for leak-free joints

Model	 NPT	 in	 ft
<b>SWIVEL COUPLING AT ONE END</b>			
P14-10	1/4"	1/4"	10'
P14-20	1/4"	1/4"	20'
P14-30	1/4"	1/4"	30'
P38-10	3/8"	3/8"	10'
P38-20	3/8"	3/8"	20'
P38-30	3/8"	3/8"	30'
<b>SWIVEL COUPLING AT BOTH ENDS</b>			
P12-10R	1/2"	1/2"	10'
P12-20R	1/2"	1/2"	20'
P12-30R	1/2"	1/2"	30'





### Fitting Kits

Model	Specifications
P14-RMS	1/4" NPT reusable male swivel fitting kit for 1/4" ID polyurethane hose
P38-RMS	3/8" NPT reusable male swivel fitting kit for 3/8" ID polyurethane hose
P14-RMR	1/4" NPT reusable male rigid fitting kit for 1/4" ID polyurethane hose
P38-RMR	3/8" NPT reusable male rigid fitting kit for 3/8" ID polyurethane hose
P12-RFR	1/2" NPT reusable female rigid fitting kit for 1/2" ID polyurethane hose
P12-RMS	1/2" NPT reusable male rigid fitting kit for 1/2" ID polyurethane hose

## Swivels

### Swivel Connectors



Model	 NPT	 cfm*	Description
ASA-1/4	1/4"	0 - 25	Adjustable swivel connectors
ASC-1/4	1/4"	0 - 33	Non-marring composite swivel connectors
AS-3/8	3/8"	0 - 45	Standard swivel connectors
AS-1/2	1/2"	0 - 65	Standard swivel connectors

### Swivels and Adapters



Model	 NPT	Description
636077	1/8" (M) x 1/8" (F)	Z swivel
636086-B	1/4" (M) x 1/4" (F)	Z swivel
636087-B	1/4" (M) x 1/4" (F) w/ filter element	Z swivel
635106	1/2" (F) x 3/8" (M)	Z swivel
636075	1/8" (M) x 1/8" (F)	Straight swivel
636085	3/8" (M) x 3/8" (F)	Straight swivel
635107	3/8" (M) x 1/2" (F)	Straight swivel
635117	1/2" (M) x 1/2" (F)	Straight swivel
635108	3/4" (M) x 3/4" (F)	Straight swivel
3249	1/8" (F) x 1/8" (F)	Female adapter
676	1/8" (M) x 1/8" (M)	Male adapter

### Swivel Inlets



Model	Specifications
HH1-VSW1/2	1/2" NPT x 1/2" hose barb (general-duty)
HH1-VSW7/8	7/8" - 24" x 1/2" hose barb (general-duty)

### Inlet Bushings with Screens



Model	Description
ROB1J61-565	1/4" male pipe to 1/4" female pipe



## Air Hose Nipples

### Female Pipe Thread



### Male Pipe Thread



Model	 NPT	 in (mm)
<b>FEMALE PIPE THREADS</b>		
R00-147	3/8"	3/8" (10)
R1-47	3/8"	5/16" (8)
<b>MALE PIPE THREADS</b>		
A01-46	3/8"	1/2" (13)
A03-46	1/2"	3/4" (19)
AL-387	3/8"	5/16" (8)
CN-20-S	2"	2" (51)
D01-14	1/4"	3/8" (10)
D02-455	1/2"	1/2" (13)
IR30127	1/4"	5/16" (8)
IR6225	3/8"	3/8" (10)
IR78217	1/4"	1/4" (6)
J3-581	3/4"	3/4" (19)
P35-46	1"	1" (25)
R00-146	1/8"	3/8" (10)

## Hose Clamps



Model	 OD in (mm)	Description
MT1-AL34-3/8	3/8" (10 mm)	1 braid rayon
MT1-AL34-1/2	1/2" (13 mm)	1 braid rayon
MT1-AL34-3/4	3/4" (19 mm)	1 braid rayon
MT1-AL34-1	1" (25 mm)	1 braid rayon

\*At 90 psig inlet and 10 psig pressure drop.

# Couplers & Plugs



## Couplers & Plugs

Ingersoll Rand is your link to enhanced productivity through our complete selection of threaded and hose barb couplers and connectors. Available in multiple sizes and profiles, our couplers and plugs are durable and corrosion resistant, making them ideal for demanding shop environments.

### ARO Series

**Features**

- Automatic, pin-type couplers
- Designed for one-way shutoff operation
- All couplers / plugs average flow cfm measured at 90 psi inlet and 10 psig pressure drop

**Female Couplers**



**Male Couplers**



**Female Plugs**



**Male Plugs**



Model	Female NPT; Male NPT; Hose Stem ID	Body Size in	NPT		cfm*
			↓	↑	
<b>FEMALE COUPLERS</b>					
210	Female NPT	1/4"	1/4"		18
ARCF33	Female NPT	3/8"	3/8"		60
ARCH33	Hose Stem ID	3/8"	3/8"		60
<b>MALE COUPLERS</b>					
ARCH23	Hose Stem ID	1/4"	3/8"		18
ARCM22	Male NPT	1/4"	1/4"		18
ARCM23	Male NPT	1/4"	3/8"		18
ARCH33	Hose Stem ID	3/8"	3/8"		60
ARCM33	Male NPT	3/8"	3/8"		60

Model	Female NPT; Male NPT; Hose Stem ID	Body Size in	NPT		cfm*
			↓	↑	
<b>FEMALE PLUGS</b>					
ARPF22	Female NPT	1/4"	1/4"		18
ARPH22	Hose Stem ID	1/4"	1/4"		18
ARPH23	Hose Stem ID	1/4"	3/8"		18
ARPH25	Hose Stem ID	1/4"	5/16"		18
ARPF33	Female NPT	3/8"	3/8"		60
ARPH33	Hose Stem ID	3/8"	3/8"		60
<b>MALE PLUGS</b>					
ARPH22	Hose Stem ID	1/4"	1/4"		18
ARPH23	Hose Stem ID	1/4"	3/8"		18
ARPH25	Hose Stem ID	1/4"	5/16"		18
ARPM21	Male NPT	1/4"	1/8"		18
ARPM22	Male NPT	1/4"	1/4"		18
ARPH33	Hose Stem ID	3/8"	3/8"		60
ARPM32	Male NPT	3/8"	1/4"		60
ARPM33	Male NPT	3/8"	3/8"		60

\*At 90 psig inlet and 10 psig pressure drop.

## MS Series Industrial Interchange

### Features

- Economical automatic-type, one-way shutoff coupler
- Easy, push-to-connect use
- All couplers / plugs average flow cfm measured at 90 psi inlet and 10 psig pressure drop

#### Female Couplers



#### Male Couplers



#### Female Plugs



#### Male Plugs



Model	Manual NPT; Automatic NPT; Hose Stem ID	Body Size		cfm*
		in	NPT	
<b>FEMALE COUPLERS</b>				
MSCF22	Automatic NPT	1/4"	1/4"	36
MSCF23	Automatic NPT	1/4"	3/8"	36
MSCH22	Hose Stem ID	1/4"	1/4"	36
MSCH23	Hose Stem ID	1/4"	3/8"	36
420ATH	Manual NPT	3/8"	3/8"	67
440ATH	Manual NPT	3/8"	1/2"	67
MSCH33	Hose Stem ID	3/8"	3/8"	67
MSCF44	Automatic NPT	1/2"	1/2"	126
<b>MALE COUPLERS</b>				
MSCH22	Hose Stem ID	1/4"	1/4"	36
MSCH23	Hose Stem ID	1/4"	3/8"	36
MSCM22	Automatic NPT	1/4"	1/4"	36
MSCM23	Automatic NPT	1/4"	3/8"	36
HFCM32	Automatic NPT	3/8"	1/4"	67
430ATH	Manual NPT	3/8"	3/8"	67
MSCH33	Hose Stem ID	3/8"	3/8"	67
MSCH44	Hose Stem ID	1/2"	1/2"	126

Model	Female NPT; Male NPT; Hose Stem ID	Body Size		cfm*
		in	NPT	
<b>FEMALE PLUGS</b>				
MSPF21	Female NPT	1/4"	1/8"	36
MSPF22	Female NPT	1/4"	1/4"	36
MSPF23	Female NPT	1/4"	3/8"	36
MSPH22	Hose Stem ID	1/4"	1/4"	36
MSPH23	Hose Stem ID	1/4"	3/8"	36
45ATH	Female NPT	3/8"	1/2"	67
MSPF32	Female NPT	3/8"	1/4"	67
MSPF33	Female NPT	3/8"	3/8"	67
MSPH33	Hose Stem ID	3/8"	3/8"	67
MSPH34	Hose Stem ID	3/8"	1/2"	67
MSPF43	Female NPT	1/2"	3/8"	126
MSPF44	Female NPT	1/2"	1/2"	126
MSPH44	Hose Stem ID	1/2"	1/2"	126
<b>MALE PLUGS</b>				
MSPH22	Hose Stem ID	1/4"	1/4"	36
MSPH23	Hose Stem ID	1/4"	3/8"	36
MSPM21	Male NPT	1/4"	1/8"	36
MSPM22	Male NPT	1/4"	1/4"	36
MSPM23	Male NPT	1/4"	3/8"	36
MSPH33	Hose Stem ID	3/8"	3/8"	67
MSPH34	Hose Stem ID	3/8"	1/2"	67
MSPM32	Male NPT	3/8"	1/4"	67
MSPM34	Male NPT	3/8"	1/2"	67
PRPM33	Male NPT	3/8"	3/8"	67
MSPM43	Male NPT	1/2"	3/8"	126

## PR Series

### Features

- Made of non-marring composite
- Safety coupler eliminates accidental disconnects
- Easy connect, disconnect
- Allows you to bleed hoses
- Shockproof and crush-resistant
- All couplers / plugs average flow cfm measured at 90 psi inlet and 10 psig pressure drop
- Carbonitride steel with anti-corrosion protection
- Teflon coating on all male threads

#### Female Couplers



#### Male Couplers



#### Hose Barb Couplers



#### Female Plugs



#### Male Plugs



#### Hose Barb Plugs



Model	Body Size		cfm*
	in	NPT	
<b>FEMALE COUPLERS</b>			
PRSGF22	1/4"	1/4"	32
PRSGF23	1/4"	3/8"	32
PRSGF33	3/8"	3/8"	64
PRSGF34	3/8"	1/2"	64
PRSGF43	1/2"	3/8"	147
PRSGF44	1/2"	1/2"	147
PRSGF46	1/2"	3/4"	147
<b>MALE COUPLERS</b>			
PRSGM22	1/4"	1/4"	32
PRSGM23	1/4"	3/8"	32
PRSGM33	3/8"	3/8"	64
PRSGM34	3/8"	1/2"	64
<b>HOSE BARB COUPLERS</b>			
PRSGH22	1/4"	1/4"	32
PRSGH23	3/8"	1/4"	32
PRSGH33	3/8"	3/8"	64
PRSGH34	1/2"	3/8"	64
PRSGH44	1/2"	1/2"	147
PRSGH45	5/8"	1/2"	147
PRSGH46	3/4"	1/2"	147

Model	Body Size	
	in	NPT
<b>FEMALE PLUGS</b>		
PRPF22	1/4"	1/4"
PRPF23	1/4"	3/8"
PRPF32	3/8"	1/4"
PRPF33	3/8"	3/8"
PRPF44	1/2"	1/2"
<b>MALE PLUGS</b>		
PRPM22	1/4"	1/4"
PRPM23	1/4"	3/8"
PRPM32	3/8"	1/4"
PRPM33	3/8"	3/8"
<b>HOSE BARB PLUGS</b>		
PRPH22	1/4"	1/4"
PRPH23	3/8"	1/4"
PRPH33	3/8"	3/8"
PRPH34	1/2"	3/8"
PRPH44	1/2"	1/2"
PRPH45	5/8"	1/2"
PRPH46	3/4"	1/2"

\*At 90 psig inlet and 10 psig pressure drop.



## Type "A" Series

- Features**
- Full-flow, non-shutoff couplers
  - Designed for heavy-duty services
  - Simple, sturdy, and able to withstand hard usage and abuse
  - Couplers and plugs are compatible within the same Body Size

### Hose Stem Couplers



### Male NPT Couplers







### Hose Stem Plugs



### Male NPT Plugs



Model	Body Size		
<b>HOSE STEM COUPLERS</b>			
FH-8-1/2	5/8"	1/2" Hose	3/8"
FH-8-3/4	5/8"	3/4" Hose	9/16"
FH-8-1	1"	1" Hose	13/16"
<b>MALE NPT COUPLERS</b>			
FO-8-3/4	5/8"	3/4" MNPT	5/8"
FO-8-3/8	5/8"	3/8" MNPT	3/8"
FO-8-1/2	1"	1" MNPT	15/16"

Model	Body Size		
<b>HOSE STEM PLUGS</b>			
MH-8-1/2	5/8"	1/2" Hose	3/8"
MH-8-3/4	5/8"	3/4" Hose	5/8"
MH-8A-1	5/8"	1" Hose	13/16"
<b>MALE NPT PLUGS</b>			
MO-8-1/2	5/8"	1/2" MNPT	3/8"
MO-8-3/4	5/8"	3/4" MNPT	5/8"
MO-8A-1	1"	1" MNPT	13/16"

### O-Rings for Type "A" Couplers





Model	NPT / Hose Stem End Size	Used in Model
BU-948	5/8"	FH Series, FO Series
R4-103	1"	FH Series, FO Series

## Safety Air Fuse Valves

- Features**
- Value designed to meet OSHA requirements
  - Provides automatic pressure reduction if a hose is cut, ruptures, or accidentally uncouples, thus preventing the hose from whipping
  - Constant bleed hole in the valve allows the flow check to automatically open, or reset, after repair to the hose is made
  - Brass body and adapter; stainless steel spring; celcon valve
  - All parts are corrosion-resistant
  - Max temperature: 180° F
  - Max allowable working pressure: 250 psig (17 bar)



Model	Cut-off Flow Rate @ 90 psig			
170-6	112 - 128	3/4"	1-1/4" (31.8)	3"
170-8	220 - 260	1"	1-1/2" (38.1)	3-1/8"

Note: Turn off air supply before disconnecting.

## Universal Hose Couplers

- Features**
- Full-flow, non-shutoff couplers
  - Gaskets and clips are included with all universal couplers

### Universal 3-way



Model	Hose Size (in)
UW-300-B	1/4" to 1"

### Universal Male Pipe Threaded Ends



Model	Hose Size (in)
UM-37-M	3/8"
UM-50-M	1/2"
UM-75-M	3/4"
UM-100-M	1"

### Universal Dead End



Model	Hose Size (in)
UD-301-M	1/4" to 1"

### Universal Hose Ends



Model	Hose Size (in)
UH-50-M	1/2"
UH-75-M	3/4"
UH-100-M	1"

### Universal Female Pipe Threaded Ends



Model	Hose Size (in)
UF-50-M	1/2"
UF-75-M	3/4"
UF-100-M	1"

### Universal Coupler Gasket



Model	Specifications
UG-100	For use in any universal coupler

# Impact Sockets



## Features & Benefits

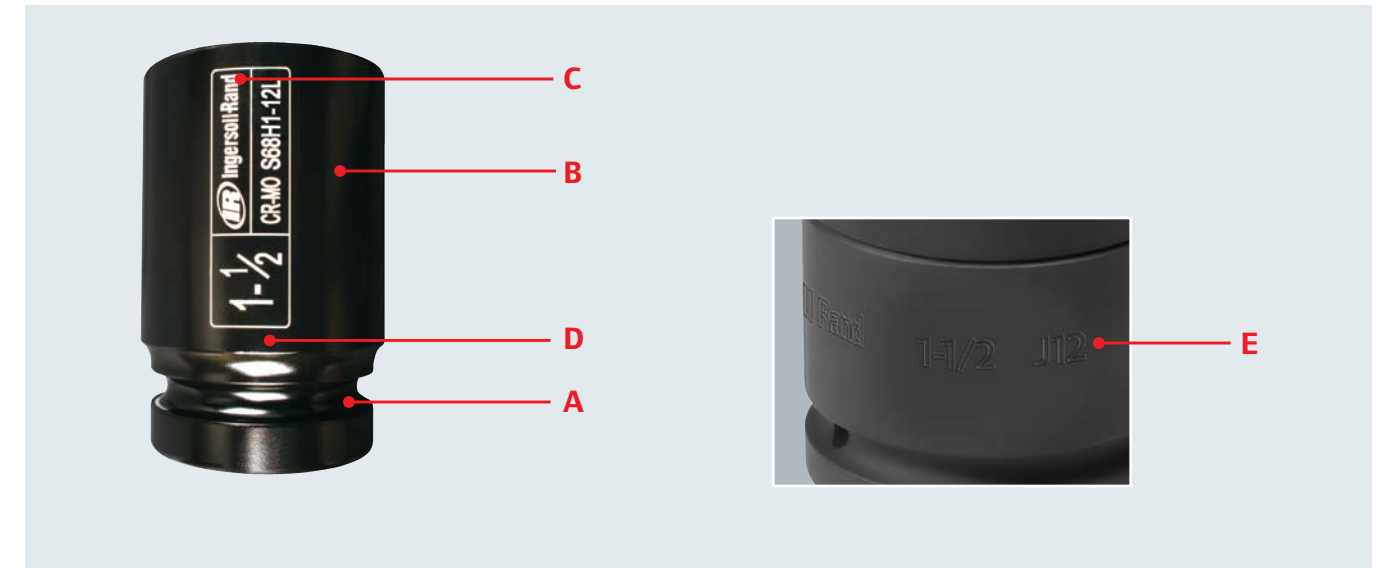

Features	Benefits
<b>A</b> Impact-grade toughness	Designed for high-torque applications
<b>B</b> Chrome-molybdenum steel	Forged for high-strength durability
<b>C</b> Laser-etched size labeling	Enables easy size identification
<b>D</b> Electro-phosphate finish on 1/4" to 1" drive sizes	Projects a sleek look and high visibility
<b>E</b> Durable roll stamp feature on 1-1/2", 2-1/2", and #5 Spline drive sizes	Enables easy size identification in harsh work environments
Backed by a Lifetime Warranty	Provides peace of mind with proven reliability

Impact Sockets



# 1/4" Square Drive Impact Sockets

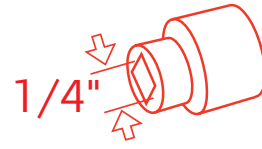

SK2C10

## Sets

Part Number	# of Pieces	Description	Contents
SK2C10	10	1/4" Drive combo set	3/16", 1/4", 3/8", 1/2", 9/16", 4 mm, 6 mm, 9 mm, 12 mm, 14 mm
SK2H6	6	1/4" Drive standard set	3/16", 1/4", 3/8", 7/16", 1/2", 9/16"
SK2M6	6	1/4" Drive metric set	4 mm, 6 mm, 8 mm, 10 mm, 12 mm, 14 mm
SK2M12	12	1/4" Drive metric standard set	6 mm, 7 mm, 8 mm, 9 mm, 10 mm, 11 mm, 12 mm, 13 mm, 14 mm, 50 mm extension, 100 mm extension, 3/8" female to 1/4" male adapter

## Individuals

6-PT	Part Number	Output Size	D1 in (mm)	D2 in (mm)	T in (mm)	L in (mm)	Type
<b>STANDARD</b>							
	S62H316	3/16"	0.33 (8.5)	0.51 (13)	0.2 (5)	0.91 (23)	A
	S62H732	7/32"	0.37 (9.5)	0.51 (13)	0.2 (5)	0.91 (23)	A
	S62H14	1/4"	0.41 (10.3)	0.51 (13)	0.2 (5)	0.91 (23)	A
	S62H932	9/32"	0.44 (11.3)	0.51 (13)	0.28 (7)	0.91 (23)	A
	S62H516	5/16"	0.49 (12.5)	0.51 (13)	0.28 (7)	0.91 (23)	A
	S62H1132	11/32"	0.55 (14)	0.55 (14)	0.28 (7)	0.91 (23)	B
	S62H38	3/8"	0.63 (16)	0.63 (16)	0.31 (8)	0.91 (23)	B
	S62H716	7/16"	0.67 (17)	0.67 (17)	0.31 (8)	0.91 (23)	B
	S62H12	1/2"	0.75 (19)	0.75 (19)	0.31 (8)	0.91 (23)	B
	S62H916	9/16"	0.79 (20)	0.79 (20)	0.31 (8)	0.91 (23)	B
	S62M4	4 mm	0.3 (7.6)	0.51 (13)	0.2 (5)	0.91 (23)	A
	S62M45	4.5 mm	0.32 (8.2)	0.51 (13)	0.2 (5)	0.91 (23)	A
	S62M5	5 mm	0.35 (8.8)	0.51 (13)	0.2 (5)	0.91 (23)	A
	S62M55	5.5 mm	0.37 (9.5)	0.51 (13)	0.2 (5)	0.91 (23)	A
	S62M6	6 mm	0.39 (10)	0.51 (13)	0.28 (7)	0.91 (23)	A
S62M7	7 mm	0.44 (11.3)	0.51 (13)	0.28 (7)	0.91 (23)	A	
S62M8	8 mm	0.49 (12.5)	0.51 (13)	0.28 (7)	0.91 (23)	A	
S62M9	9 mm	0.55 (14)	0.55 (14)	0.28 (7)	0.91 (23)	B	
S62M10	10 mm	0.57 (14.5)	0.57 (14.5)	0.28 (7)	0.91 (23)	B	
S62M11	11 mm	0.67 (17)	0.67 (17)	0.31 (8)	0.91 (23)	B	
S62M12	12 mm	0.71 (18)	0.71 (18)	0.31 (8)	0.91 (23)	B	
S62M13	13 mm	0.75 (19)	0.75 (19)	0.31 (8)	0.91 (23)	B	
S62M14	14 mm	0.79 (20)	0.79 (20)	0.31 (8)	0.91 (23)	B	
S62M15	15 mm	0.83 (21)	0.83 (21)	0.31 (8)	0.91 (23)	B	

6-PT	Part Number	Output Size	D1 in (mm)	D2 in (mm)	T in (mm)	L in (mm)	Type
<b>DEEP</b>							
	S62H316L	3/16"	0.33 (8.5)	0.51 (13)	0.2 (5)	1.97 (50)	A
	S62H732L	7/32"	0.37 (9.5)	0.51 (13)	0.2 (5)	1.97 (50)	A
	S62H14L	1/4"	0.41 (10.3)	0.51 (13)	0.2 (5)	1.97 (50)	A
	S62H932L	9/32"	0.44 (11.3)	0.51 (13)	0.28 (7)	1.97 (50)	A
	S62H516L	5/16"	0.49 (12.5)	0.51 (13)	0.28 (7)	1.97 (50)	A
	S62H1132L	11/32"	0.55 (14)	0.55 (14)	0.28 (7)	1.97 (50)	B
	S62H38L	3/8"	0.63 (16)	0.63 (16)	0.31 (8)	1.97 (50)	B
	S62H716L	7/16"	0.67 (17)	0.67 (17)	0.31 (8)	1.97 (50)	B
	S62H12L	1/2"	0.75 (19)	0.75 (19)	0.31 (8)	1.97 (50)	B
	S62H916L	9/16"	0.79 (20)	0.79 (20)	0.31 (8)	1.97 (50)	B
	S62M4L	4 mm	0.3 (7.6)	0.51 (13)	0.2 (5)	1.97 (50)	A
	S62M45L	4.5 mm	0.32 (8.2)	0.51 (13)	0.2 (5)	1.97 (50)	A
	S62M5L	5 mm	0.35 (8.8)	0.51 (13)	0.2 (5)	1.97 (50)	A
	S62M55L	5.5 mm	.37 (9.5)	0.51 (13)	0.2 (5)	1.97 (50)	A
	S62M6L	6 mm	0.39 (10)	0.51 (13)	0.28 (7)	1.97 (50)	A
S62M7L	7 mm	0.44 (11.3)	0.51 (13)	0.28 (7)	1.97 (50)	A	
S62M8L	8 mm	0.49 (12.5)	0.51 (13)	0.28 (7)	1.97 (50)	A	
S62M9L	9 mm	0.57 (14.5)	0.57 (14.5)	0.28 (7)	1.97 (50)	B	
S62M10L	10 mm	0.63 (16)	0.63 (16)	0.28 (7)	1.97 (50)	B	
S62M11L	11 mm	0.67 (17)	0.67 (17)	0.31 (8)	1.97 (50)	B	
S62M12L	12 mm	0.67 (17)	0.67 (17)	0.31 (8)	1.97 (50)	B	
S62M13L	13 mm	.75 (19)	0.75 (19)	0.31 (8)	1.97 (50)	B	
S62M14L	14 mm	0.79 (20)	0.79 (20)	0.31 (8)	1.97 (50)	B	
S62M15L	15 mm	0.83 (21)	0.83 (21)	0.31 (8)	1.97 (50)	B	
<b>UNIVERSAL</b>							
	S62H14U	1/4"	0.47 (12)	0.63 (16)	0.24 (6)	1.73 (44)	A
	S62H516U	5/16"	0.51 (13)	0.63 (16)	0.24 (6)	1.73 (44)	A
	S62H38U	3/8"	0.63 (16)	0.63 (16)	0.31 (8)	1.73 (44)	A
	S62H716U	7/16"	0.67 (17)	0.63 (16)	0.31 (8)	1.73 (44)	A
	S62H12U	1/2"	0.75 (19)	0.63 (16)	0.31 (8)	1.89 (48)	A
	S62H916U	9/16"	0.79 (20)	0.63 (16)	0.31 (8)	1.89 (48)	A
	S62M5U	5 mm	0.47 (12)	0.63 (16)	0.24 (6)	1.73 (44)	A
	S62M55U	5.5 mm	0.47 (12)	0.71 (18)	0.24 (6)	1.73 (44)	A
	S62M6U	6 mm	0.47 (12)	0.71 (18)	0.24 (6)	1.73 (44)	A
	S62M7U	7 mm	0.47 (12)	0.71 (18)	0.24 (6)	1.73 (44)	A
	S62M8U	8 mm	0.51 (13)	0.71 (18)	0.31 (8)	1.73 (44)	A
	S62M9U	9 mm	0.59 (15)	0.71 (18)	0.31 (8)	1.73 (44)	A
	S62M10U	10 mm	0.63 (16)	0.71 (18)	0.31 (8)	1.73 (44)	A
	S62M11U	11 mm	0.67 (17)	0.71 (18)	0.31 (8)	1.73 (44)	A
	S62M12U	12 mm	0.67 (17)	0.71 (18)	0.31 (8)	1.89 (48)	A
S62M13U	13 mm	0.75 (19)	0.71 (18)	0.31 (8)	1.89 (48)	A	
S62M14U	14 mm	0.79 (20)	0.71 (18)	0.31 (8)	1.89 (48)	A	
S62M15U	15 mm	0.83 (21)	0.71 (18)	0.31 (8)	1.89 (48)	A	



### Accessories

	Description	Output Size
<b>A2F3M</b>	1/4" female to 3/8" male adapter	3/8"
<b>J2</b>	Universal joint	1/4"
<b>E22H</b>	2" Extension	1/4"
<b>E24H</b>	4" Extension	1/4"
<b>E26H</b>	6" Extension	1/4"



Adapter

## 3/8" Square Drive Impact Sockets

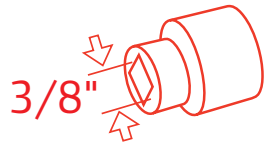

### Sets

Part Number	# of Pieces	Description	Contents
<b>SK3H8</b>	8	3/8" Drive standard set	5/16", 3/8", 7/16", 1/2", 9/16", 5/8", 11/16", 3/4"
<b>SK3H8L</b>	8	3/8" Drive deep standard set	5/16", 3/8", 7/16", 1/2", 9/16", 5/8", 11/16", 3/4"
<b>SK3H7U</b>	7	3/8" Drive universal set	3/8", 7/16", 1/2", 9/16", 5/8", 11/16", 3/4"
<b>SK3M8</b>	8	3/8" Drive metric set	9 mm, 10 mm, 11 mm, 13 mm, 14 mm, 15 mm, 17 mm, 19 mm
<b>SK3M8L</b>	8	3/8" Drive deep metric set	9 mm, 10 mm, 11 mm, 13 mm, 14 mm, 15 mm, 17 mm, 19 mm
<b>SK3M7U</b>	7	3/8" Universal metric set	10 mm, 12 mm, 13 mm, 14 mm, 15 mm, 17 mm, 19 mm
<b>SK3C8</b>	8	3/8" Combo drive SAE & metric set	3/8", 1/2", 5/8", 11/16", 10 mm, 13 mm, 16 mm, 17 mm
<b>SK3M10</b>	10	3/8" drive metric standard set	9 mm, 10 mm, 11 mm, 12 mm, 13 mm, 14 mm, 15 mm, 16 mm, 17 mm, 19 mm



SK3H8

### Individuals

6-PT	Part Number	Output Size	D1 in (mm)	D2 in (mm)	T in (mm)	L in (mm)	Type
STANDARD	S63H14	1/4"	0.43 (11)	0.75 (19)	0.16 (4)	1.1 (28)	A
	S63H516	5/16"	0.49 (12.5)	0.75 (19)	0.28 (7)	1.1 (28)	A
	S63H38	3/8"	0.57 (14.5)	0.75 (19)	0.28 (7)	1.1 (28)	A
	S63H716	7/16"	0.67 (17)	0.75 (19)	0.28 (7)	1.18 (30)	A
	S63H12	1/2"	0.75 (19)	0.75 (19)	0.28 (7)	1.18 (30)	B
	S63H916	9/16"	0.79 (20)	0.79 (20)	0.28 (7)	1.18 (30)	B
	S63H58	5/8"	0.94 (24)	0.94 (24)	0.39 (10)	1.18 (30)	B
	S63H1116	11/16"	0.94 (24)	0.94 (24)	0.39 (10)	1.26 (32)	B
	S63H34	3/4"	1.02 (26)	1.02 (26)	0.39 (10)	1.26 (32)	B
	S63H1316	13/16"	1.18 (30)	1.18 (30)	0.51 (13)	1.26 (32)	B
	S63H78	7/8"	1.26 (32)	1.26 (32)	0.51 (13)	1.26 (32)	B
	S63H1516	15/16"	1.34 (34)	1.34 (34)	0.51 (13)	1.26 (32)	B
	S63H1	1 mm	1.34 (34)	1.34 (34)	0.51 (13)	1.26 (32)	B
	S63M6	6 mm	0.41 (10.5)	0.75 (19)	0.16 (4)	1.1 (28)	A
	S63M7	7 mm	0.45 (11.5)	0.75 (19)	0.28 (7)	1.1 (28)	A
	S63M8	8 mm	0.49 (12.5)	0.75 (19)	0.28 (7)	1.1 (28)	A
	S63M9	9 mm	0.55 (14)	0.75 (19)	0.28 (7)	1.1 (28)	A
	S63M10	10 mm	0.59 (15)	0.75 (19)	0.28 (7)	1.1 (28)	A

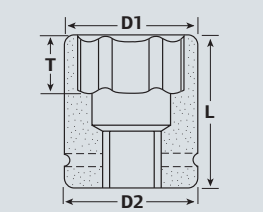

6-PT	Part Number	Output Size	D1 in (mm)	D2 in (mm)	T in (mm)	L in (mm)	Type
<b>STANDARD (cont'd)</b>							
	S63M11	11 mm	0.67 (17)	0.75 (19)	0.28 (7)	1.18 (30)	A
	S63M12	12 mm	0.71 (18)	0.75 (19)	0.28 (7)	1.18 (30)	A
	S63M13	13 mm	0.75 (19)	0.75 (19)	0.28 (7)	1.18 (30)	B
	S63M14	14 mm	0.79 (20)	0.79 (20)	0.28 (7)	1.18 (30)	B
	S63M15	15 mm	0.87 (22)	0.87 (22)	0.39 (10)	1.18 (30)	B
	S63M16	16 mm	0.94 (24)	0.94 (24)	0.39 (10)	1.18 (30)	B
	S63M17	17 mm	0.94 (24)	0.94 (24)	0.39 (10)	1.26 (32)	B
	S63M18	18 mm	1.02 (26)	1.02 (26)	0.51 (13)	1.26 (32)	B
	S63M19	19 mm	1.02 (26)	1.02 (26)	0.51 (13)	1.26 (32)	B
	S63M20	20 mm	1.1 (28)	1.1 (28)	0.51 (13)	1.26 (32)	B
	S63M21	21 mm	1.18 (30)	1.18 (30)	0.51 (13)	1.26 (32)	B
	S63M22	22 mm	1.26 (32)	1.26 (32)	0.51 (13)	1.26 (32)	B
<b>DEEP</b>							
	S63H516L	5/16"	0.49 (12.5)	0.75 (19)	0.47 (12)	2.48 (63)	A
	S63H38L	3/8"	0.57 (14.5)	0.75 (19)	0.55 (14)	2.48 (63)	A
	S63H716L	7/16"	0.67 (17)	0.75 (19)	0.67 (17)	2.48 (63)	A
	S63H12L	1/2"	0.75 (19)	0.75 (19)	0.67 (17)	2.48 (63)	B
	S63H916L	9/16"	0.79 (20)	0.79 (20)	0.67 (17)	2.48 (63)	B
	S63H58L	5/8"	0.94 (24)	0.94 (24)	0.67 (17)	2.48 (63)	B
	S63H1116L	11/16"	0.94 (24)	0.94 (24)	0.67 (17)	2.48 (63)	B
	S63H34L	3/4"	1.02 (26)	1.02 (26)	0.75 (19)	2.48 (63)	B
	S63H1316L	13/16"	1.18 (30)	1.18 (30)	0.75 (19)	2.48 (63)	B
	S63H78L	7/8"	1.26 (32)	1.26 (32)	0.75 (19)	2.48 (63)	B
	S63H1516L	15/16"	1.34 (34)	1.34 (34)	0.83 (21)	2.48 (63)	B
	S63H1L	1 mm	1.42 (36)	1.42 (36)	0.83 (21)	2.48 (63)	B
	S63M7L	7 mm	0.45 (11.5)	0.75 (19)	0.43 (11)	2.48 (63)	A
	S63M8L	8 mm	0.49 (12.5)	0.75 (19)	0.47 (12)	2.48 (63)	A
	S63M9L	9 mm	0.55 (14)	0.75 (19)	0.55 (14)	2.48 (63)	A
	S63M10L	10 mm	0.59 (15)	0.75 (19)	0.55 (14)	2.48 (63)	A
	S63M11L	11 mm	0.67 (17)	0.75 (19)	0.67 (17)	2.48 (63)	A
	S63M12L	12 mm	0.71 (18)	0.75 (19)	0.67 (17)	2.48 (63)	A
	S63M13L	13 mm	0.75 (19)	0.75 (19)	0.67 (17)	2.48 (63)	B
	S63M14L	14 mm	0.79 (20)	0.79 (20)	0.67 (17)	2.48 (63)	B
	S63M15L	15 mm	0.87 (22)	0.87 (22)	0.75 (19)	2.48 (63)	B
	S63M16L	16 mm	0.94 (24)	0.94 (24)	0.75 (19)	2.48 (63)	B
	S63M17L	17 mm	0.94 (24)	0.94 (24)	0.75 (19)	2.48 (63)	B
	S63M18L	18 mm	1.02 (26)	1.02 (26)	0.75 (19)	2.48 (63)	B
	S63M19L	19 mm	1.02 (26)	1.02 (26)	0.83 (21)	2.48 (63)	B
	S63M20L	20 mm	1.1 (28)	1.1 (28)	0.83 (21)	2.48 (63)	B
	S63M21L	21 mm	1.18 (30)	1.18 (30)	0.83 (21)	2.48 (63)	B
	S63M22L	22 mm	1.26 (32)	1.26 (32)	0.83 (21)	2.48 (63)	B

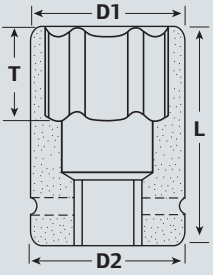

6-PT	Part Number	Output Size	D1 in (mm)	D2 in (mm)	T in (mm)	L in (mm)	Type
<b>UNIVERSAL</b>							
	S63H516U	5/16"	0.69 (17.5)	0.94 (24)	0.47 (12)	2.09 (53)	A
	S63H38U	3/8"	0.59 (15)	0.94 (24)	0.47 (12)	2.09 (53)	A
	S63H716U	7/16"	0.73 (18.5)	0.94 (24)	0.47 (12)	2.09 (53)	A
	S63H12U	1/2"	0.75 (19)	0.94 (24)	0.47 (12)	2.09 (53)	A
	S63H916U	9/16"	0.87 (22)	0.94 (24)	0.47 (12)	2.09 (53)	A
	S63H58U	5/8"	0.94 (24)	0.94 (24)	0.47 (12)	2.09 (53)	A
	S63H1116U	11/16"	0.98 (25)	0.94 (24)	0.47 (12)	2.09 (53)	A
	S63H34U	3/4"	1.1 (28)	0.94 (24)	0.47 (12)	2.09 (53)	A
	S63H1316U	13/16"	1.26 (32)	0.94 (24)	0.47 (12)	2.09 (53)	A
	S63H78U	7/8"	1.26 (32)	0.94 (24)	0.47 (12)	2.09 (53)	A
	S63H1516U	15/16"	1.34 (34)	0.94 (24)	0.47 (12)	2.09 (53)	A
	S63H1U	1 mm	1.42 (36)	0.94 (24)	0.47 (12)	2.09 (53)	A
	S63M8U	8 mm	0.69 (17.5)	0.94 (24)	0.47 (12)	2.09 (53)	A
	S63M9U	9 mm	0.69 (17.5)	0.94 (24)	0.47 (12)	2.09 (53)	A
	S63M10U	10 mm	0.65 (16.5)	0.94 (24)	0.47 (12)	2.09 (53)	A
	S63M11U	11 mm	0.75 (19)	0.94 (24)	0.47 (12)	2.09 (53)	A
	S63M12U	12 mm	0.75 (19)	0.94 (24)	0.47 (12)	2.09 (53)	A
	S63M13U	13 mm	0.79 (20)	0.94 (24)	0.47 (12)	2.09 (53)	A
	S63M14U	14 mm	0.87 (22)	0.94 (24)	0.47 (12)	2.09 (53)	A
	S63M15U	15 mm	0.87 (22)	0.94 (24)	0.47 (12)	2.09 (53)	A
	S63M16U	16 mm	1.02 (26)	0.94 (24)	0.47 (12)	2.09 (53)	A
	S63M17U	17 mm	1.02 (26)	0.94 (24)	0.47 (12)	2.09 (53)	A
	S63M18U	18 mm	1.02 (26)	0.94 (24)	0.47 (12)	2.09 (53)	A
	S63M19U	19 mm	1.1 (28)	0.94 (24)	0.47 (12)	2.09 (53)	A
	S63M20U	20 mm	1.26 (32)	0.94 (24)	0.47 (12)	2.09 (53)	A
	S63M21U	21 mm	1.26 (32)	0.94 (24)	0.47 (12)	2.09 (53)	A
	S63M22U	22 mm	1.26 (32)	0.94 (24)	0.47 (12)	2.09 (53)	A
<b>UNIVERSAL DEEP</b>							
	S63H516UL	5/16"	0.69 (17.5)	0.94 (24)	0.51 (13)	3.03 (77)	A
	S63H38UL	3/8"	0.71 (18)	0.94 (24)	0.51 (13)	3.03 (77)	A
	S63H716UL	7/16"	0.71 (18)	0.94 (24)	0.51 (13)	3.03 (77)	A
	S63H12UL	1/2"	0.75 (19)	0.94 (24)	0.51 (13)	3.03 (77)	A
	S63H916UL	9/16"	0.83 (21)	0.94 (24)	0.51 (13)	3.03 (77)	A
	S63H58UL	5/8"	0.91 (23)	0.94 (24)	0.51 (13)	3.03 (77)	A
	S63H1116UL	11/16"	0.98 (25)	0.94 (24)	0.51 (13)	3.03 (77)	A
	S63H34UL	3/4"	1.06 (27)	0.94 (24)	0.51 (13)	3.03 (77)	A
	S63H1316UL	13/16"	1.18 (30)	0.94 (24)	0.51 (13)	3.03 (77)	A
	S63H78UL	7/8"	1.26 (32)	0.94 (24)	0.51 (13)	3.03 (77)	A
	S63M8UL	8 mm	0.69 (17.5)	0.94 (24)	0.51 (13)	3.03 (77)	A
	S63M9UL	9 mm	0.69 (17.5)	0.94 (24)	0.51 (13)	3.03 (77)	A
	S63M10UL	10 mm	0.71 (18)	0.94 (24)	0.51 (13)	3.03 (77)	A

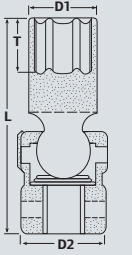
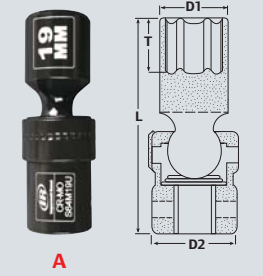
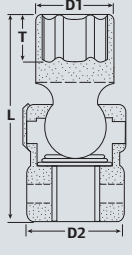
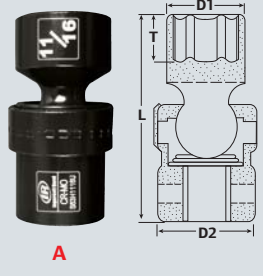

6-PT	Part Number	Output Size	D1 in (mm)	D2 in (mm)	T in (mm)	L in (mm)	Type
UNIVERSAL DEEP (cont'd)							
	S63M11UL	11 mm	0.71 (18)	0.94 (24)	0.51 (13)	3.03 (77)	A
	S63M12UL	12 mm	0.75 (19)	0.94 (24)	0.51 (13)	3.03 (77)	A
	S63M13UL	13 mm	0.75 (19)	0.94 (24)	0.51 (13)	3.03 (77)	A
	S63M14UL	14 mm	0.83 (21)	0.94 (24)	0.51 (13)	3.03 (77)	A
	S63M15UL	15 mm	0.87 (22)	0.94 (24)	0.51 (13)	3.03 (77)	A
	S63M16UL	16 mm	1.02 (26)	0.94 (24)	0.51 (13)	3.03 (77)	A
	S63M17UL	17 mm	0.98 (25)	0.94 (24)	0.51 (13)	3.03 (77)	A
	S63M18UL	18 mm	1.02 (26)	0.94 (24)	0.51 (13)	3.03 (77)	A
	S63M19UL	19 mm	1.06 (27)	0.94 (24)	0.51 (13)	3.03 (77)	A
	S63M20UL	20 mm	1.1 (28)	0.94 (24)	0.51 (13)	3.03 (77)	A
	S63M21UL	21 mm	1.18 (30)	0.94 (24)	0.51 (13)	3.03 (77)	A
	S63M22UL	22 mm	1.26 (32)	0.94 (24)	0.51 (13)	3.03 (77)	A

Accessories

Description	Output Size	Recommended Retaining Ring
<b>A3F2M</b> 3/8" female to 1/4" male adapter	1/4"	RR10003
<b>A3F4M</b> 3/8" female to 1/2" male adapter	1/2"	RR10003
<b>J3</b> Universal joint	3/8"	—
<b>E33H</b> 3" Extension	3/8"	RR10003
<b>E36H</b> 6" Extension	3/8"	RR10003
<b>E312H</b> 12" Extension	3/8"	RR10003



Adapter



Extension

1/2" Square Drive Impact Sockets

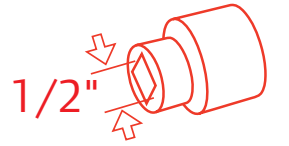

Sets

Part Number	# of Pieces	Description	Contents
<b>SK4M3L</b>	3	1/2" Drive deep metric set	17 mm, 19 mm, 21 mm
<b>SK4M5L</b>	5	1/2" Drive deep metric set	17 mm, 19 mm, 21mm, 22 mm, 24 mm
<b>SK4M8L</b>	8	1/2" Drive deep metric set	11 mm, 13 mm, 15 mm, 16 mm, 17 mm, 18 mm, 19 mm, 21 mm
<b>SK4H10L</b>	10	1/2" Drive deep standard set	7/16", 1/2", 9/16", 5/8", 11/16", 3/4", 13/16", 7/8", 15/16", 1"
<b>SK4C10L</b>	10	1/2" Drive deep combo set	1/2", 9/16", 5/8", 3/4", 7/8", 13 mm, 16 mm, 17 mm, 19 mm, 21 mm
<b>SK4LNR</b>	8	1/2" Drive metric lug nut removal set	17 mm, 18.5 mm, 20 mm, 21.5 mm, 23 mm, 24.5 mm, 26 mm, 27.5 mm
<b>SK4M18</b>	18	1/2" Drive metric	Standard: 10 mm, 11 mm, 13mm, 14 mm, 17 mm, 19 mm, 21 mm, 22 mm, 24 mm Deep: 13 mm, 14 mm, 21 mm, 24 mm Deep Thin Wall: 17 mm, 19 mm, 21 mm
<b>SK4H13</b>	13	1/2" Drive standard set	7/16", 1/2", 9/16", 5/8", 11/16", 3/4", 13/16", 7/8", 15/16", 1", 1-1/16", 1-1/8", 1-1/4"
<b>SK4H13L</b>	13	1/2" Drive deep standard set	7/16", 1/2", 9/16", 5/8", 11/16", 3/4", 13/16", 7/8", 15/16", 1", 1-1/16", 1-1/8", 1-1/4"
<b>SK4H7U</b>	7	1/2" Drive universal set	1/2", 9/16", 5/8", 11/16", 3/4", 13/16", 7/8"
<b>SK4M14</b>	14	1/2" Drive metric standard set	10 mm, 11 mm, 12 mm, 13 mm, 14 mm, 15 mm, 1 mm, 17 mm, 18 mm, 19 mm, 21 mm, 22 mm, 26 mm, 27 mm
<b>SK4M4L</b>	4	1/2" Drive deep metric axle nut kit	30 mm, 32 mm, 34 mm, 36 mm
<b>SK4M7U</b>	7	1/2" Drive universal metric set	13 mm, 14 mm, 15 mm, 17 mm, 19 mm, 21 mm, 22 mm
<b>SK4C3F</b>	3	1/2" Drive lug nut service set (flip socket set)	3/4" x 13/16", 19" x 21", 3" Extension
<b>SK34C86</b>	86	3/8" & 1/2" Combo standard & deep socket set	Includes all sockets in SK3H8, SK3H8L, SK3M8, SK3M8L, SK4H13, SK4H13L, SK4M14, & SK4M14L



SK4H13



Individuals

6-PT							
Part Number	Output Size	D1 in (mm)	D2 in (mm)	T in (mm)	L in (mm)	Type	
<b>STANDARD</b>							
S64H1516	15/16"	1.34 (34)	1.34 (34)	0.63 (16)	1.73 (44)	B	
S64H38	3/8"	0.63 (16)	0.87 (22)	0.43 (11)	1.5 (38)	A	
S64H716	7/16"	0.71 (18)	0.87 (22)	0.43 (11)	1.5 (38)	A	
S64H12	1/2"	0.77 (19.5)	0.87 (22)	0.43 (11)	1.5 (38)	A	
S64H916	9/16"	0.85 (21.5)	0.94 (24)	0.43 (11)	1.5 (38)	A	
S64H58	5/8"	0.94 (24)	0.94 (24)	0.43 (11)	1.5 (38)	B	
S64H1116	11/16"	1.02 (26)	1.02 (26)	0.43 (11)	1.5 (38)	B	
S64H34	3/4"	1.1 (28)	1.1 (28)	0.63 (16)	1.57 (40)	B	
S64H1316	13/16"	1.18 (30)	1.18 (30)	0.63 (16)	1.57 (40)	B	
S64H78	7/8"	1.26 (32)	1.26 (32)	0.63 (16)	1.65 (42)	B	
S64H1516	15/16"	1.34 (34)	1.34 (34)	0.63 (16)	1.73 (44)	B	
S64H1	1"	1.42 (36)	1.42 (36)	0.71 (18)	1.73 (44)	B	
S64H1-116	1-1/16"	1.5 (38)	1.5 (38)	0.71 (18)	1.81 (46)	B	
S64H1-18	1-1/8"	1.57 (40)	1.5 (38)	0.71 (18)	1.81 (46)	C	
S64H1-316	1-3/16"	1.65 (42)	1.5 (38)	0.71 (18)	1.81 (46)	C	
S64H1-14	1-1/4"	1.73 (44)	1.5 (38)	0.79 (20)	1.81 (46)	C	
S64H1-516	1-5/16"	1.85 (47)	1.5 (38)	0.79 (20)	1.81 (46)	C	
S64H1-38	1-3/8"	1.97 (50)	1.5 (38)	0.79 (20)	1.81 (46)	C	
S64H1-716	1-7/16"	2.01 (51)	1.5 (38)	0.79 (20)	1.81 (46)	C	
S64H1-12	1-1/2"	2.09 (53)	1.5 (38)	0.87 (22)	1.81 (46)	C	
S64H1-916	1-9/16"	2.17 (55)	1.73 (44)	0.87 (22)	2.36 (60)	C	
S64H1-58	1-5/8"	2.28 (58)	1.73 (44)	0.87 (22)	2.36 (60)	C	
S64H1-1116	1-11/16"	2.4 (61)	1.73 (44)	0.94 (24)	2.36 (60)	C	
S64H1-34	1-3/4"	2.48 (63)	1.73 (44)	0.94 (24)	2.36 (60)	C	
S64H1-1316	1-13/16"	2.56 (65)	1.73 (44)	0.94 (24)	2.36 (60)	C	
S64H1-78	1-7/8"	2.6 (66)	1.73 (44)	0.94 (24)	2.36 (60)	C	
S64H1-1516	1-15/16"	2.68 (68)	1.73 (44)	0.94 (24)	2.36 (60)	C	
S64H2	2"	2.76 (70)	2.05 (52)	0.94 (24)	2.36 (60)	C	
S64H2-116	2-1/16"	2.83 (72)	2.05 (52)	0.94 (24)	2.36 (60)	C	
S64H2-18	2-1/8"	2.99 (76)	2.05 (52)	1.06 (27)	2.56 (65)	C	
S64H2-316	2-3/16"	3.03 (77)	2.05 (52)	1.06 (27)	2.56 (65)	C	
S64H2-14	2-1/4"	3.15 (80)	2.05 (52)	1.06 (27)	2.56 (65)	C	
S64M8	8 mm	0.57 (14.5)	0.87 (22)	0.35 (9)	1.5 (38)	A	
S64M9	9 mm	0.57 (14.5)	0.87 (22)	0.43 (11)	1.5 (38)	A	
S64M10	10 mm	0.67 (17)	0.87 (22)	0.43 (11)	1.5 (38)	A	
S64M11	11 mm	0.67 (17)	0.87 (22)	0.43 (11)	1.5 (38)	A	
S64M12	12 mm	0.71 (18)	0.87 (22)	0.43 (11)	1.5 (38)	A	
S64M13	13 mm	0.79 (20)	0.87 (22)	0.43 (11)	1.5 (38)	A	
S64M14	14 mm	0.87 (22)	0.94 (24)	0.43 (11)	1.5 (38)	A	
S64M15	15 mm	0.94 (24)	0.94 (24)	0.43 (11)	1.5 (38)	B	

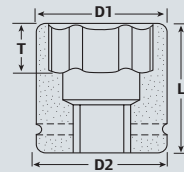

6-PT							
Part Number	Output Size	D1 in (mm)	D2 in (mm)	T in (mm)	L in (mm)	Type	
<b>STANDARD (cont'd)</b>							
S64M16	16 mm	0.94 (24)	0.94 (24)	0.43 (11)	1.5 (38)	B	
S64M17	17 mm	1.02 (26)	1.02 (26)	0.43 (11)	1.5 (38)	B	
S64M18	18 mm	1.02 (26)	1.02 (26)	0.43 (11)	1.5 (38)	B	
S64M19	19 mm	1.1 (28)	1.1 (28)	0.51 (13)	1.57 (40)	B	
S64M20	20 mm	1.18 (30)	1.18 (30)	0.51 (13)	1.57 (40)	B	
S64M21	21 mm	1.18 (30)	1.18 (30)	0.51 (13)	1.57 (40)	B	
S64M22	22 mm	1.26 (32)	1.26 (32)	0.51 (13)	1.65 (42)	B	
S64M23	23 mm	1.26 (32)	1.26 (32)	0.51 (13)	1.65 (42)	B	
S64M24	24 mm	1.34 (34)	1.34 (34)	0.59 (15)	1.73 (44)	B	
S64M25	25 mm	1.38 (35)	1.38 (35)	0.59 (15)	1.73 (44)	B	
S64M26	26 mm	1.42 (36)	1.42 (36)	0.59 (15)	1.73 (44)	B	
S64M27	27 mm	1.5 (38)	1.5 (38)	0.72 (18.3)	1.81 (46)	B	
S64M28	28 mm	1.57 (40)	1.5 (38)	0.72 (18.3)	1.81 (46)	C	
S64M29	29 mm	1.57 (40)	1.5 (38)	0.72 (18.3)	1.81 (46)	C	
S64M30	30 mm	1.65 (42)	1.5 (38)	0.72 (18.3)	1.81 (46)	C	
S64M32	32 mm	1.73 (44)	1.5 (38)	0.72 (18.3)	1.81 (46)	C	
S64M33	33 mm	1.77 (45)	1.5 (38)	0.79 (20)	1.81 (46)	C	
S64M34	34 mm	1.81 (46)	1.5 (38)	0.79 (20)	1.81 (46)	C	
S64M35	35 mm	1.89 (48)	1.5 (38)	0.79 (20)	1.81 (46)	C	
S64M36	36 mm	1.97 (50)	1.5 (38)	0.79 (20)	1.97 (50)	C	
<b>DEEP</b>							
S64H516L	5/16"	0.55 (14)	0.87 (22)	0.39 (10)	3.07 (78)	A	
S64H38L	3/8"	0.67 (17)	0.87 (22)	0.55 (14)	3.07 (78)	A	
S64H716L	7/16"	0.71 (18)	0.87 (22)	0.55 (14)	3.07 (78)	A	
S64H12L	1/2"	0.79 (20)	0.87 (22)	0.55 (14)	3.07 (78)	A	
S64H916L	9/16"	0.87 (22)	0.94 (24)	0.55 (14)	3.07 (78)	A	
S64H58L	5/8"	0.94 (24)	0.94 (24)	0.55 (14)	3.07 (78)	B	
S64H1116L	11/16"	1.02 (26)	1.02 (26)	0.67 (17)	3.07 (78)	B	
S64H34L	3/4"	1.1 (28)	1.1 (28)	0.67 (17)	3.07 (78)	B	
S64H1316L	13/16"	1.18 (30)	1.18 (30)	0.67 (17)	3.07 (78)	B	
S64H78L	7/8"	1.26 (32)	1.26 (32)	0.75 (19)	3.07 (78)	B	
S64H1516L	15/16"	1.34 (34)	1.34 (34)	0.75 (19)	3.07 (78)	B	
S64H1L	1"	1.42 (36)	1.42 (36)	0.75 (19)	3.07 (78)	B	
S64H1-116L	1-1/16"	1.5 (38)	1.5 (38)	0.75 (19)	3.07 (78)	B	
S64H1-18L	1-1/8"	1.57 (40)	1.5 (38)	0.75 (19)	3.07 (78)	C	
S64H1-316L	1-3/16"	1.65 (42)	1.5 (38)	0.75 (19)	3.07 (78)	C	
S64H1-14L	1-1/4"	1.73 (44)	1.5 (38)	1.18 (30)	3.07 (78)	C	
S64H1-516L	1-5/16"	1.85 (47)	1.5 (38)	1.18 (30)	3.15 (80)	C	
S64H1-38L	1-3/8"	1.97 (50)	1.5 (38)	1.18 (30)	3.15 (80)	C	
S64H1-716L	1-7/16"	2.01 (51)	1.5 (38)	1.18 (30)	3.15 (80)	C	

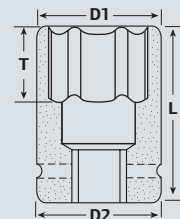

Impact Sockets

Impact Sockets

6-PT	Part Number	Output Size	D1 in (mm)	D2 in (mm)	T in (mm)	L in (mm)	Type
<b>DEEP (cont'd)</b>							
	S64H1-12L	1-1/2"	2.09 (53)	1.5 (38)	1.18 (30)	3.15 (80)	C
	S64H1-916L	1-9/16"	2.17 (55)	1.73 (44)	1.3 (33)	3.54 (90)	C
	S64H1-58L	1-5/8"	2.28 (58)	1.73 (44)	1.3 (33)	3.54 (90)	C
	S64H1-1116L	1-11/16"	2.4 (61)	1.73 (44)	1.3 (33)	3.54 (90)	C
	S64H1-34L	1-3/4"	2.48 (63)	1.73 (44)	1.3 (33)	3.54 (90)	C
	S64H1-1316L	1-13/16"	2.56 (65)	1.73 (44)	1.38 (35)	3.54 (90)	C
	S64H1-78L	1-7/8"	2.6 (66)	1.73 (44)	1.38 (35)	3.54 (90)	C
	S64H1-1516L	1-15/16"	2.68 (68)	1.73 (44)	1.38 (35)	3.54 (90)	C
	S64H2L	2"	2.76 (70)	2.05 (52)	1.38 (35)	3.54 (90)	C
	S64H2-116	2-1/16"	2.83 (72)	2.05 (52)	1.38 (35)	3.54 (90)	C
	S64H2-18L	2-1/8"	2.99 (76)	2.05 (52)	1.38 (35)	3.54 (90)	C
	S64H2-316L	2-3/16"	3.03 (77)	2.05 (52)	1.38 (35)	3.54 (90)	C
	S64H2-14L	2-1/4"	3.15 (80)	2.05 (52)	1.38 (35)	3.54 (90)	C
	S64M8L	8 mm	0.55 (14)	0.87 (22)	0.43 (11)	3.07 (78)	A
	S64M9L	9 mm	0.59 (15)	0.87 (22)	0.55 (14)	3.07 (78)	A
	S64M10L	10 mm	0.67 (17)	0.87 (22)	0.55 (14)	3.07 (78)	A
	S64M11L	11 mm	0.71 (18)	0.87 (22)	0.55 (14)	3.07 (78)	A
	S64M12L	12 mm	0.75 (19)	0.87 (22)	0.55 (14)	3.07 (78)	A
	S64M13L	13 mm	0.79 (20)	0.94 (24)	0.55 (14)	3.07 (78)	A
	S64M14L	14 mm	0.87 (22)	0.94 (24)	0.75 (19)	3.07 (78)	A
	S64M15L	15 mm	0.94 (24)	0.94 (24)	0.75 (19)	3.07 (78)	B
	S64M16L	16 mm	0.94 (24)	0.94 (24)	0.75 (19)	3.07 (78)	B
	S64M17L	17 mm	1.02 (26)	1.02 (26)	0.75 (19)	3.07 (78)	B
	S64M18L	18 mm	1.02 (26)	1.02 (26)	0.75 (19)	3.07 (78)	B
	S64M19L	19 mm	1.1 (28)	1.1 (28)	0.75 (19)	3.07 (78)	B
	S64M20L	20 mm	1.18 (30)	1.18 (30)	0.75 (19)	3.07 (78)	B
	S64M21L	21 mm	1.18 (30)	1.18 (30)	0.83 (21)	3.07 (78)	B
	S64M22L	22 mm	1.26 (32)	1.26 (32)	0.83 (21)	3.07 (78)	B
	S64M23L	23 mm	1.26 (32)	1.26 (32)	0.83 (21)	3.07 (78)	B
	S64M24L	24 mm	1.34 (34)	1.34 (34)	0.83 (21)	3.07 (78)	B
	S64M25L	25 mm	1.38 (35)	1.38 (35)	0.83 (21)	3.07 (78)	B
	S64M26L	26 mm	1.42 (36)	1.42 (36)	0.83 (21)	3.07 (78)	B
	S64M27L	27 mm	1.5 (38)	1.5 (38)	0.83 (21)	3.07 (78)	B
	S64M28L	28 mm	1.57 (40)	1.5 (38)	0.94 (24)	3.07 (78)	C
	S64M29L	29 mm	1.57 (40)	1.5 (38)	0.94 (24)	3.07 (78)	C
	S64M30L	30 mm	1.65 (42)	1.5 (38)	0.94 (24)	3.07 (78)	C
	S64M32L	32 mm	1.73 (44)	1.5 (38)	0.94 (24)	3.07 (78)	C
	S64M33L	33 mm	1.77 (45)	1.5 (38)	0.94 (24)	3.07 (78)	C
	S64M34L	34 mm	1.89 (48)	1.5 (38)	0.94 (24)	3.07 (78)	C
	S64M35L	35 mm	1.89 (48)	1.5 (38)	0.94 (24)	3.07 (78)	C
	S64M36L	36 mm	1.97 (50)	1.5 (38)	0.94 (24)	3.07 (78)	C

6-PT	Part Number	Output Size	D1 in (mm)	D2 in (mm)	T in (mm)	L in (mm)	Type
<b>UNIVERSAL</b>							
	S64H516U	5/16"	0.75 (19)	1.1 (28)	0.51 (13)	2.6 (66)	A
	S64H38U	3/8"	0.75 (19)	1.1 (28)	0.51 (13)	2.6 (66)	A
	S64H716U	7/16"	0.75 (19)	1.1 (28)	0.51 (13)	2.6 (66)	A
	S64H12U	1/2"	0.75 (19)	1.1 (28)	0.51 (13)	2.6 (66)	A
	S64H916U	9/16"	0.87 (22)	1.1 (28)	0.51 (13)	2.6 (66)	A
	S64H58U	5/8"	0.94 (24)	1.1 (28)	0.51 (13)	2.6 (66)	A
	S64H1116U	11/16"	1.02 (26)	1.1 (28)	0.51 (13)	2.6 (66)	A
	S64H34U	3/4"	1.1 (28)	1.1 (28)	0.51 (13)	2.6 (66)	A
	S64H1316U	13/16"	1.18 (30)	1.1 (28)	0.51 (13)	2.6 (66)	A
	S64H78U	7/8"	1.26 (32)	1.1 (28)	0.51 (13)	2.6 (66)	A
	S64H1516U	15/16"	1.42 (36)	1.1 (28)	0.51 (13)	2.6 (66)	A
	S64M10U	10 mm	0.75 (19)	1.1 (28)	0.51 (13)	2.6 (66)	A
	S64M11U	11 mm	0.75 (19)	1.1 (28)	0.51 (13)	2.6 (66)	A
	S64M12U	12 mm	0.75 (19)	1.1 (28)	0.51 (13)	2.6 (66)	A
	S64M13U	13 mm	0.87 (22)	1.1 (28)	0.51 (13)	2.6 (66)	A
	S64M14U	14 mm	0.87 (22)	1.1 (28)	0.51 (13)	2.6 (66)	A
	S64M15U	15 mm	0.91 (23)	1.1 (28)	0.51 (13)	2.6 (66)	A
	S64M16U	16 mm	1.02 (26)	1.1 (28)	0.51 (13)	2.6 (66)	A
	S64M17U	17 mm	1.02 (26)	1.1 (28)	0.51 (13)	2.6 (66)	A
	S64M18U	18 mm	1.02 (26)	1.1 (28)	0.51 (13)	2.6 (66)	A
	S64M19U	19 mm	1.1 (28)	1.1 (28)	0.51 (13)	2.6 (66)	A
	S64M20U	20 mm	1.18 (30)	1.1 (28)	0.51 (13)	2.6 (66)	A
	S64M21U	21 mm	1.18 (30)	1.1 (28)	0.51 (13)	2.6 (66)	A
	S64M22U	22 mm	1.26 (32)	1.1 (28)	0.51 (13)	2.6 (66)	A
	S64M23U	23 mm	1.26 (32)	1.1 (28)	0.51 (13)	2.6 (66)	A
	S64M24U	24 mm	1.34 (34)	1.1 (28)	0.51 (13)	2.6 (66)	A
<b>UNIVERSAL DEEP</b>							
	S64H38UL	3/8"	0.87 (22)	1.1 (28)	0.55 (14)	3.54 (90)	A
	S64H716UL	7/16"	0.87 (22)	1.1 (28)	0.67 (17)	3.54 (90)	A
	S64H12UL	1/2"	0.87 (22)	1.1 (28)	0.67 (17)	3.54 (90)	A
	S64H916UL	9/16"	0.87 (22)	1.1 (28)	0.67 (17)	3.54 (90)	A
	S64H58UL	5/8"	0.94 (24)	1.1 (28)	0.67 (17)	3.54 (90)	A
	S64H1116UL	11/16"	1.02 (26)	1.1 (28)	0.67 (17)	3.54 (90)	A
	S64H34UL	3/4"	1.1 (28)	1.1 (28)	0.67 (17)	3.54 (90)	A
	S64H1316UL	13/16"	1.18 (30)	1.1 (28)	0.67 (17)	3.54 (90)	A
	S64H78UL	7/8"	1.26 (32)	1.1 (28)	0.67 (17)	3.54 (90)	A
	S64H1516UL	15/16"	1.34 (34)	1.1 (28)	0.67 (17)	3.54 (90)	A
	S64M10UL	10 mm	0.87 (22)	1.1 (28)	0.55 (14)	3.54 (90)	A
	S64M11UL	11 mm	0.87 (22)	1.1 (28)	0.67 (17)	3.54 (90)	A
	S64M12UL	12 mm	0.87 (22)	1.1 (28)	0.67 (17)	3.54 (90)	A
	S64M13UL	13 mm	0.87 (22)	1.1 (28)	0.67 (17)	3.54 (90)	A

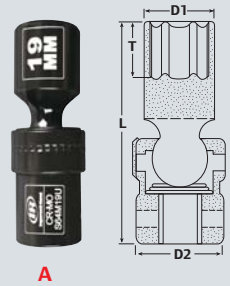
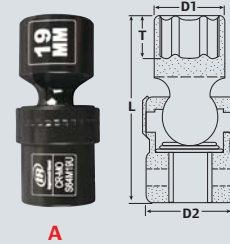

6-PT	Part Number	Output Size	D1 in (mm)	D2 in (mm)	T in (mm)	L in (mm)	Type
UNIVERSAL DEEP (cont'd)							
	S64M14UL	14 mm	0.87 (22)	1.1 (28)	0.67 (17)	3.54 (90)	A
	S64M15UL	15 mm	0.94 (24)	1.1 (28)	0.67 (17)	3.54 (90)	A
	S64M16UL	16 mm	60.94 (24)	1.1 (28)	0.67 (17)	3.54 (90)	A
	S64M17UL	17 mm	1.02 (26)	1.1 (28)	0.67 (17)	3.54 (90)	A
	S64M18UL	18 mm	1.02 (26)	1.1 (28)	0.67 (17)	3.54 (90)	A
	S64M19UL	19 mm	1.1 (28)	1.1 (28)	0.67 (17)	3.54 (90)	A
	S64M20UL	20 mm	1.18 (30)	1.1 (28)	0.67 (17)	3.54 (90)	A
	S64M21UL	21 mm	1.18 (30)	1.1 (28)	0.67 (17)	3.54 (90)	A
	S64M22UL	22 mm	1.26 (32)	1.1 (28)	0.67 (17)	3.54 (90)	A
	S64M23UL	23 mm	1.26 (32)	1.1 (28)	0.67 (17)	3.54 (90)	A
	S64M24UL	24 mm	1.34 (34)	1.1 (28)	0.67 (17)	3.54 (90)	A

Accessories

Description	Output Size	Recommended Retaining Ring
<b>A4F3M</b> 1/2" female to 3/8" male adapter	3/8"	RR10006
<b>A4F6M</b> 1/2" female to 3/4" male adapter	3/4"	RR10008
<b>J4</b> Universal joint	1/2"	—
<b>E43H</b> 3" Extension	1/2"	RR10006
<b>E45H</b> 5" Extension	1/2"	RR10006
<b>E47H</b> 7" Extension	1/2"	RR10006
<b>E410H</b> 10" Extension	1/2"	RR10006
<b>E418H</b> 18" Extension	1/2"	RR10006
<b>E424H</b> 24" Extension	1/2"	RR10006
<b>E436H</b> 36" Extension	1/2"	RR10006



3/4" Square Drive Impact Sockets

Sets

Part Number	# of Pieces	Description	Contents
<b>SK6H8</b>	8	3/4" Drive standard set	1", 1-1/16", 1-1/8", 1-1/4", 1-5/16", 1-3/8", 1-7/16", 1-1/2"
<b>SK6H8L</b>	8	3/4" Drive deep standard set	1", 1-1/16", 1-1/8", 1-1/4", 1-5/16", 1-3/8", 1-7/16", 1-1/2"
<b>SK6M6L</b>	6	3/4" Drive deep metric set	24 mm, 27 mm, 30 mm, 32 mm, 33 mm, 36 mm



Individuals

6-PT	Part Number	Output Size	D1 in (mm)	D2 in (mm)	T in (mm)	L in (mm)	Type	Recommended Retaining Ring
STANDARD								
	S66H12	1/2"	0.91 (23)	1.63 (41.4)	0.51 (13)	2.01 (51)	A	RR10010
	S66H916	9/16"	1 (25.5)	1.63 (41.4)	0.51 (13)	2.01 (51)	A	RR10010
	S66H58	5/8"	1.1 (28)	1.63 (41.4)	0.51 (13)	2.01 (51)	A	RR10010
	S66H1116	11/16"	1.16 (29.5)	1.63 (41.4)	0.51 (13)	2.01 (51)	A	RR10010
	S66H34	3/4"	1.26 (32)	1.63 (41.4)	0.51 (13)	2.01 (51)	A	RR10010
	S66H1316	13/16"	1.38 (35)	1.63 (41.4)	0.51 (13)	2.01 (51)	A	RR10010
	S66H78	7/8"	1.42 (36)	1.63 (41.4)	0.51 (13)	2.01 (51)	A	RR10010
	S66H1516	15/16"	1.52 (38.5)	1.63 (41.4)	0.51 (13)	2.01 (51)	A	RR10010
	S66H1	1"	1.57 (40)	1.63 (41.4)	0.51 (13)	2.09 (53)	A	RR10010
	S66H1-116	1-1/16"	1.67 (42.5)	1.73 (44)	0.51 (13)	2.09 (53)	A	RR10034S
	S66H1-18	1-1/8"	1.73 (44)	1.73 (44)	0.63 (16)	2.09 (53)	B	RR10034S
	S66H1-316	1-3/16"	1.81 (46)	1.73 (44)	0.63 (16)	2.09 (53)	C	RR10034S
	S66H1-14	1-1/4"	1.89 (48)	1.73 (44)	0.63 (16)	2.24 (57)	C	RR10034S
	S66H1-516	1-5/16"	1.97 (50)	1.73 (44)	0.75 (19)	2.24 (57)	C	RR10034S
	66H1-38	1-3/8"	2.07 (52.5)	1.73 (44)	0.75 (19)	2.24 (57)	C	RR10034S
	S66H1-716	1-7/16"	2.11 (53.5)	1.73 (44)	0.75 (19)	2.24 (57)	C	RR10034S
	S66H1-12	1-1/2"	2.2 (56)	1.73 (44)	0.87 (22)	2.24 (57)	C	RR10034S
	S66H1-916	1-9/16"	2.3 (58.5)	1.73 (44)	0.87 (22)	2.28 (58)	C	RR10034S
	S66H1-58	1-5/8"	2.36 (60)	1.73 (44)	0.87 (22)	2.28 (58)	C	RR10034S
	S66H1-1116	1-11/16"	2.5 (63.5)	1.73 (44)	1.02 (26)	2.44 (62)	C	RR10034S
	S66H1-34	1-3/4"	2.54 (64.5)	1.73 (44)	1.02 (26)	2.44 (62)	C	RR10034S
	S66H1-1316	1-13/16"	2.6 (66)	1.73 (44)	1.02 (26)	2.44 (62)	C	RR10034S





6-PT								
Part Number	Output Size	D1 in (mm)	D2 in (mm)	T in (mm)	L in (mm)	Type	Recommended Retaining Ring	
STANDARD (cont'd)								
S66H1-78	1-7/8"	2.68 (68)	1.73 (44)	1.06 (27)	2.68 (68)	C	RR10034S	
S66H1-1516	1-15/16"	2.76 (70)	1.73 (44)	1.06 (27)	2.68 (68)	C	RR10034S	
S66H2	2"	2.8 (71)	1.73 (44)	1.06 (27)	2.68 (68)	C	RR10034S	
S66H2-116	2-1/16"	2.91 (74)	2.13 (54)	1.22 (31)	2.8 (71)	C	RR10015S	
SS6H2-18	2-1/8"	2.99 (76)	2.13 (54)	1.22 (31)	2.8 (71)	C	RR10015S	
S66H2-316	2-3/16"	3.07 (78)	2.13 (54)	1.22 (31)	2.8 (71)	C	RR10015S	
S66H2-14	2-1/4"	3.15 (80)	2.13 (54)	1.3 (33)	2.87 (73)	C	RR10015S	
S66H2-516	2-5/16"	3.21 (81.5)	2.13 (54)	1.3 (33)	2.87 (73)	C	RR10015S	
S66H2-38	2-3/8"	3.29 (83.5)	2.13 (54)	1.34 (34)	2.87 (73)	C	RR10015S	
S66H2-716	2-7/16"	3.35 (85)	2.13 (54)	1.34 (34)	2.95 (75)	C	RR10015S	
S66H2-12	2-1/2"	3.41 (86.5)	2.13 (54)	1.34 (34)	2.95 (75)	C	RR10015S	
S66M17	17 mm	1.18 (30)	1.73 (44)	0.51 (13)	2.01 (51)	A	RR10034S	
S66M18	18 mm	1.22 (31)	1.73 (44)	0.51 (13)	2.01 (51)	A	RR10034S	
S66M19	19 mm	1.28 (32.5)	1.73 (44)	0.51 (13)	2.01 (51)	A	RR10034S	
S66M20	20 mm	1.32 (33.5)	1.73 (44)	0.51 (13)	2.01 (51)	A	RR10034S	
S66M21	21 mm	1.38 (35)	1.73 (44)	0.51 (13)	2.01 (51)	A	RR10034S	
S66M22	22 mm	1.42 (36)	1.73 (44)	0.51 (13)	2.01 (51)	A	RR10034S	
S66M23	23 mm	1.48 (37.5)	1.73 (44)	0.51 (13)	2.01 (51)	A	RR10034S	
S66M24	24 mm	1.52 (38.5)	1.73 (44)	0.63 (16)	2.01 (51)	A	RR10034S	
S66M25	25 mm	1.57 (40)	1.73 (44)	0.63 (16)	2.09 (53)	A	RR10034S	
S66M26	26 mm	1.61 (41)	1.73 (44)	0.63 (16)	2.09 (53)	A	RR10034S	
S66M27	27 mm	1.67 (42.5)	1.73 (44)	0.63 (16)	2.09 (53)	A	RR10034S	
S66M28	28 mm	1.73 (44)	1.73 (44)	0.75 (19)	2.09 (53)	B	RR10034S	
S66M29	29 mm	1.77 (45)	1.73 (44)	0.75 (19)	2.09 (53)	C	RR10034S	
S66M30	30 mm	1.81 (46)	1.73 (44)	0.75 (19)	2.09 (53)	C	RR10034S	
S66M31	31 mm	1.87 (47.5)	1.73 (44)	0.75 (19)	2.24 (57)	C	RR10034S	
S66M32	32 mm	1.91 (48.5)	1.73 (44)	0.75 (19)	2.24 (57)	C	RR10034S	
S66M33	33 mm	1.97 (50)	1.73 (44)	0.87 (22)	2.24 (57)	C	RR10034S	
S66M34	34 mm	2.01 (51)	1.73 (44)	0.87 (22)	2.24 (57)	C	RR10034S	
S66M35	35 mm	2.07 (52.5)	1.73 (44)	0.87 (22)	2.24 (57)	C	RR10034S	
S66M36	36 mm	2.11 (53.5)	1.73 (44)	0.87 (22)	2.24 (57)	C	RR10034S	
S66M37	37 mm	2.17 (55)	1.73 (44)	0.87 (22)	2.24 (57)	C	RR10034S	
S66M38	38 mm	2.2 (56)	1.73 (44)	0.87 (22)	2.24 (57)	C	RR10034S	
S66M40	40 mm	2.3 (58.5)	1.73 (44)	0.87 (22)	2.28 (58)	C	RR10034S	
S66M41	41 mm	2.36 (60)	1.73 (44)	0.87 (22)	2.28 (58)	C	RR10034S	
S66M42	42 mm	2.4 (61)	1.73 (44)	0.98 (25)	2.28 (58)	C	RR10034S	
S66M43	43 mm	2.46 (62.5)	1.73 (44)	0.98 (25)	2.44 (62)	C	RR10034S	
S66M44	44 mm	2.52 (64)	1.73 (44)	0.98 (25)	2.44 (62)	C	RR10034S	
S66M46	46 mm	2.6 (66)	1.73 (44)	0.98 (25)	2.44 (62)	C	RR10034S	
S66M50	50 mm	2.8 (71)	1.73 (44)	1.18 (30)	2.68 (68)	C	RR10034S	

6-PT								
Part Number	Output Size	D1 in (mm)	D2 in (mm)	T in (mm)	L in (mm)	Type	Recommended Retaining Ring	
DEEP								
S66H12L	1/2"	0.91 (23)	1.63 (41.4)	0.63 (16)	3.54 (90)	A	RR10010	
S66H916L	9/16"	1 (25.5)	1.63 (41.4)	0.63 (16)	3.54 (90)	A	RR10010	
S66H58L	5/8"	1.1 (28)	1.63 (41.4)	0.63 (16)	3.54 (90)	A	RR10010	
S66H1116L	11/16"	1.16 (29.5)	1.63 (41.4)	0.63 (16)	3.54 (90)	A	RR10010	
S66H34L	3/4"	1.26 (32)	1.63 (41.4)	0.63 (16)	3.54 (90)	A	RR10010	
S66H1316L	13/16"	1.38 (35)	1.63 (41.4)	0.63 (16)	3.54 (90)	A	RR10010	
S66H78L	7/8"	1.42 (36)	1.63 (41.4)	0.63 (16)	3.54 (90)	A	RR10010	
S66H1516L	15/16"	1.52 (38.5)	1.63 (41.4)	0.63 (16)	3.54 (90)	A	RR10010	
S66H1L	1"	1.57 (40)	1.63 (41.4)	0.63 (16)	3.54 (90)	A	RR10010	
S66H1-116L	1-1/16"	1.67 (42.5)	1.73 (44)	0.63 (16)	3.54 (90)	A	RR10034S	
S66H1-18L	1-1/8"	1.73 (44)	1.73 (44)	0.63 (16)	3.54 (90)	B	RR10034S	
S66H1-316L	1-3/16"	1.81 (46)	1.73 (44)	0.63 (16)	3.54 (90)	C	RR10034S	
S66H1-14L	1-1/4"	1.91 (48.5)	1.73 (44)	0.63 (16)	3.54 (90)	C	RR10034S	
S66H1-516L	1-5/16"	1.97 (50)	1.73 (44)	0.87 (22)	3.54 (90)	C	RR10034S	
S66H1-38L	1-3/8"	2.07 (52.5)	1.73 (44)	0.87 (22)	3.54 (90)	C	RR10034S	
S66H1-716L	1-7/16"	2.11 (53.5)	1.73 (44)	0.87 (22)	3.54 (90)	C	RR10034S	
S66H1-12L	1-1/2"	2.2 (56)	1.73 (44)	0.87 (22)	3.54 (90)	C	RR10034S	
S66H1-916L	1-9/16"	2.3 (58.5)	1.73 (44)	0.87 (22)	3.54 (90)	C	RR10034S	
S66H1-58L	1-5/8"	2.36 (60)	1.73 (44)	0.87 (22)	3.54 (90)	C	RR10034S	
S66H1-1116L	1-11/16"	2.5 (63.5)	1.73 (44)	1.06 (27)	3.54 (90)	C	RR10034S	
S66H1-34L	1-3/4"	2.54 (64.5)	1.73 (44)	1.06 (27)	3.54 (90)	C	RR10034S	
S66H1-1316L	1-13/16"	2.6 (66)	1.73 (44)	1.06 (27)	3.54 (90)	C	RR10034S	
S66H1-78L	1-7/8"	2.68 (68)	1.73 (44)	1.06 (27)	3.54 (90)	C	RR10034S	
S66H1-1516L	1-15/16"	2.76 (70)	1.73 (44)	1.06 (27)	3.54 (90)	C	RR10034S	
S66H2L	2"	2.8 (71)	1.73 (44)	1.06 (27)	3.54 (90)	C	RR10034S	
S66H2-116L	2-1/16"	2.91 (74)	2.13 (54)	1.22 (31)	3.94 (100)	C	RR10015S	
S66H2-18L	2-1/8"	2.99 (76)	2.13 (54)	1.22 (31)	3.94 (100)	C	RR10015S	
S66H2-316L	2-3/16"	3.07 (78)	2.13 (54)	1.22 (31)	3.94 (100)	C	RR10015S	
S66H2-14L	2-1/4"	3.15 (80)	2.13 (54)	1.34 (34)	3.94 (100)	C	RR10015S	
S66H2-516L	2-5/16"	3.21 (81.5)	2.13 (54)	1.34 (34)	4.13 (105)	C	RR10015S	
S66H2-38L	2-3/8"	3.29 (83.5)	2.13 (54)	1.34 (34)	4.13 (105)	C	RR10015S	
S66H2-716L	2-7/16"	3.35 (85)	2.13 (54)	1.34 (34)	4.13 (105)	C	RR10015S	
S66H2-12L	2-1/2"	3.39 (86)	2.13 (54)	1.34 (34)	4.13 (105)	C	RR10015S	
S66M17L	17 mm	1.18 (30)	1.73 (44)	0.75 (19)	3.54 (90)	A	RR10034S	
S66M19L	19 mm	1.28 (32.5)	1.73 (44)	0.75 (19)	3.54 (90)	A	RR10034S	
S66M20L	20 mm	1.32 (33.5)	1.73 (44)	0.75 (19)	3.54 (90)	A	RR10034S	
S66M21L	21 mm	1.38 (35)	1.73 (44)	0.75 (19)	3.54 (90)	A	RR10034S	
S66M22L	22 mm	1.42 (36)	1.73 (44)	0.75 (19)	3.54 (90)	A	RR10034S	
S66M23L	23 mm	1.48 (37.5)	1.73 (44)	0.75 (19)	3.54 (90)	A	RR10034S	
S66M24L	24 mm	1.52 (38.5)	1.73 (44)	0.75 (19)	3.54 (90)	A	RR10034S	

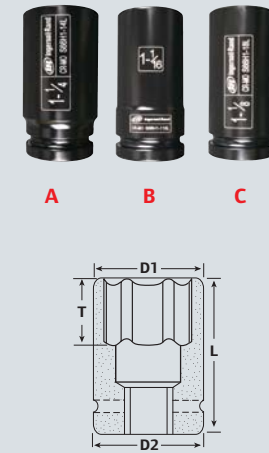

Impact Sockets

Impact Sockets

6-PT	Part Number	Output Size	D1 in (mm)	D2 in (mm)	T in (mm)	L in (mm)	Type	Recommended Retaining Ring
<b>DEEP (cont'd)</b>								
	S66M25L	25 mm	1.57 (40)	1.73 (44)	0.75 (19)	3.54 (90)	A	RR10034S
	S66M26L	26 mm	1.61 (41)	1.73 (44)	0.87 (22)	3.54 (90)	A	RR10034S
	S66M27L	27 mm	1.67 (42.5)	1.73 (44)	0.87 (22)	3.54 (90)	A	RR10034S
	S66M28L	28 mm	1.73 (44)	1.73 (44)	0.87 (22)	3.54 (90)	B	RR10034S
	S66M29L	29 mm	1.77 (45)	1.73 (44)	0.87 (22)	3.54 (90)	C	RR10034
	S66M30L	30 mm	1.81 (46)	1.73 (44)	0.87 (22)	3.54 (90)	C	RR10034S
	S66M31L	31 mm	1.87 (47.5)	1.73 (44)	0.87 (22)	3.54 (90)	C	RR10034S
	S66M32L	32 mm	1.91 (48.5)	1.73 (44)	0.87 (22)	3.54 (90)	C	RR10034S
	S66M33L	33 mm	1.97 (50)	1.73 (44)	0.98 (25)	3.54 (90)	C	RR10034S
	S66M34L	34 mm	2.01 (51)	1.73 (44)	0.98 (25)	3.54 (90)	C	RR10034S
	S66M35L	35 mm	2.07 (52.5)	1.73 (44)	0.98 (25)	3.54 (90)	C	RR10034S
	S66M36L	36 mm	2.11 (53.5)	1.73 (44)	0.98 (25)	3.54 (90)	C	RR10034S
	S66M38L	38 mm	2.2 (56)	1.73 (44)	0.98 (25)	3.54 (90)	C	RR10034S
	S66M40L	40 mm	2.3 (58.5)	1.73 (44)	1.18 (30)	3.54 (90)	C	RR10034S
	S66M41L	41 mm	2.36 (60)	1.73 (44)	1.18 (30)	3.54 (90)	C	RR10034S
	S66M42L	42 mm	2.4 (61)	1.73 (44)	1.18 (30)	3.54 (90)	C	RR10034S
	S66M43L	43 mm	2.46 (62.5)	1.73 (44)	1.18 (30)	3.54 (90)	C	RR10034S
	S66M44L	44 mm	2.52 (64)	1.73 (44)	1.18 (30)	3.54 (90)	C	RR10034S
	S66M46L	46 mm	2.6 (66)	1.73 (44)	1.18 (30)	3.54 (90)	C	RR10034S
	S66M50L	50 mm	2.8 (71)	1.73 (44)	1.18 (30)	3.54 (90)	C	RR10034S
<b>UNIVERSAL</b>								
	S66H116U	11/16"	1.14 (29)	1.73 (44)	0.51 (13)	3.74 (95)	A	RR10034S
	S66H34U	3/4"	1.26 (32)	1.73 (44)	0.51 (13)	3.74 (95)	A	RR10034S
	S66H1316U	13/16"	1.38 (35)	1.73 (44)	0.51 (13)	3.74 (95)	A	RR10034S
	S66H78U	7/8"	1.46 (37)	1.73 (44)	0.51 (13)	3.74 (95)	A	RR10034S
	S66H1516U	15/16"	1.54 (39)	1.73 (44)	0.51 (13)	3.74 (95)	A	RR10034S
	S66H1U	1"	1.61 (41)	1.73 (44)	0.51 (13)	3.94 (100)	A	RR10034S
	S66H1-116U	1-1/16"	1.69 (43)	1.73 (44)	0.67 (17)	3.94 (100)	A	RR10034S
	S66H1-18U	1-1/8"	1.73 (44)	1.73 (44)	0.67 (17)	3.94 (100)	A	RR10034S
	S66H1-316U	1-3/16"	1.85 (47)	1.73 (44)	0.67 (17)	3.94 (100)	A	RR10034S
	S66H1-14U	1-1/4"	1.93 (49)	1.73 (44)	0.67 (17)	4.13 (105)	A	RR10034S
	S66H1-516U	1-5/16"	2.01 (51)	1.73 (44)	0.75 (19)	4.13 (105)	A	RR10034S
	S66H1-38U	1-3/8"	2.09 (53)	1.73 (44)	0.75 (19)	4.13 (105)	A	RR10034S
	S66H1-716U	1-7/16"	2.13 (54)	1.73 (44)	0.75 (19)	4.33 (110)	A	RR10034S
	S66H1-12U	1-1/2"	2.24 (57)	1.73 (44)	0.87 (22)	4.33 (110)	A	RR10034S
	S66H1-916U	1-9/16"	2.36 (60)	1.73 (44)	0.87 (22)	4.33 (110)	A	RR10034S
	S66H1-58U	1-5/8"	2.36 (60)	1.73 (44)	0.87 (22)	4.53 (115)	A	RR10034S
	S66H1-1116U	1-11/16"	2.48 (63)	1.73 (44)	1.06 (27)	4.53 (115)	A	RR10034S
	S66H1-34U	1-3/4"	2.52 (64)	1.73 (44)	1.06 (27)	4.53 (115)	A	RR10034S
	S66H1-1316U	1-13/16"	2.6 (66)	1.73 (44)	1.06 (27)	4.53 (115)	A	RR10034S

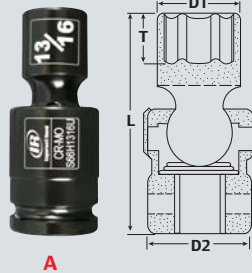

6-PT	Part Number	Output Size	D1 in (mm)	D2 in (mm)	T in (mm)	L in (mm)	Type	Recommended Retaining Ring
<b>UNIVERSAL (cont'd)</b>								
	S66H1-78U	1-7/8"	2.68 (68)	1.73 (44)	1.06 (27)	4.53 (115)	A	RR10034S
	S66M17U	17 mm	1.14 (29)	1.73 (44)	0.47 (12)	3.74 (95)	A	RR10034S
	S66M19U	19 mm	1.26 (32)	1.73 (44)	0.47 (12)	3.74 (95)	A	RR10034S
	S66M20U	20 mm	1.34 (34)	1.73 (44)	0.47 (12)	3.74 (95)	A	RR10034S
	S66M21U	21 mm	1.38 (35)	1.73 (44)	0.47 (12)	3.74 (95)	A	RR10034S
	S66M22U	22 mm	1.46 (37)	1.73 (44)	0.55 (14)	3.74 (95)	A	RR10034S
	S66M23U	23 mm	1.5 (38)	1.73 (44)	0.55 (14)	3.74 (95)	A	RR10034S
	S66M24U	24 mm	1.54 (39)	1.73 (44)	0.55 (14)	3.74 (95)	A	RR10034S
	S66M25U	25 mm	1.61 (41)	1.73 (44)	0.55 (14)	3.94 (100)	A	RR10034S
	S66M26U	26 mm	1.65 (42)	1.73 (44)	0.67 (17)	3.94 (100)	A	RR10034S
	S66M27U	27 mm	1.69 (43)	1.73 (44)	0.67 (17)	3.94 (100)	A	RR10034S
	S66M28U	28 mm	1.73 (44)	1.73 (44)	0.67 (17)	3.94 (100)	A	RR10034S
	S66M29U	29 mm	1.81 (46)	1.73 (44)	0.67 (17)	3.94 (100)	A	RR10034S
	S66M30U	30 mm	1.85 (47)	1.73 (44)	0.67 (17)	3.94 (100)	A	RR10034S
	S66M31U	31 mm	1.89 (48)	1.73 (44)	0.83 (21)	4.13 (105)	A	RR10034S
	S66M32U	32 mm	1.93 (49)	1.73 (44)	0.83 (21)	4.13 (105)	A	RR10034S
	S66M33U	33 mm	2.01 (51)	1.73 (44)	0.83 (21)	4.13 (105)	A	RR10034S
	S66M34U	34 mm	2.05 (52)	1.73 (44)	0.83 (21)	4.13 (105)	A	RR10034S
	S66M35U	35 mm	2.09 (53)	1.73 (44)	0.83 (21)	4.13 (105)	A	RR10034S
	S66M36U	36 mm	2.13 (54)	1.73 (44)	0.91 (23)	4.33 (110)	A	RR10034S
	S66M37U	37 mm	2.2 (56)	1.73 (44)	0.91 (23)	4.33 (110)	A	RR10034S
	S66M38U	38 mm	2.24 (57)	1.73 (44)	0.91 (23)	4.33 (110)	A	RR10034S
	S66M39U	39 mm	2.32(59)	1.73 (44)	0.91 (23)	4.33 (110)	A	RR10034S
	S66M40U	40 mm	2.36 (60)	1.73 (44)	0.91 (23)	4.33 (110)	A	RR10034S
	S66M41U	41 mm	2.36 (60)	1.73 (44)	1.02 (26)	4.53 (115)	A	RR10034S
	S66M42U	42 mm	2.44 (62)	1.73 (44)	1.02 (26)	4.53 (115)	A	RR10034S
	S66M43U	43 mm	2.48 (63)	1.73 (44)	1.02 (26)	4.53 (115)	A	RR10034S
	S66M44U	44 mm	2.52 (64)	1.73 (44)	1.14 (29)	4.53 (115)	A	RR10034S
	S66M45U	45 mm	2.6 (66)	1.73 (44)	1.14 (29)	4.53 (115)	A	RR10034S
	S66M46U	46 mm	2.6 (66)	1.73 (44)	1.14 (29)	4.53 (115)	A	RR10034S

### Accessories

	Description	Output Size	Recommended Retaining Ring
<b>A6F4M</b>	3/4" female to 1/2" male adapter	1/2"	RR10034S
<b>A6F8M</b>	3/4" female to 1" male adapter	1"	RR10034S
<b>A6F55M</b>	3/4" female to #5 spline male adapter	#5 Spline	RR10034S
<b>J6</b>	Universal joint	3/4"	RR10034S
<b>E63H</b>	3" Extension	3/4"	RR10034S
<b>E67H</b>	7" Extension	3/4"	RR10034S
<b>E610H</b>	10" Extension	3/4"	RR10034S
<b>E613H</b>	13" Extension	3/4"	RR10034S



Adapter



Extension

## 1" Square Drive Impact Sockets

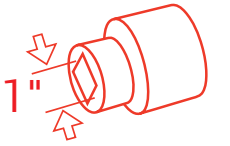

### Sets

Part Number	# of Pieces	Description	Contents
<b>SK8H8</b>	8	1" Drive standard set	7/8", 15/16", 1", 1-1/16", 1-1/8", 1-3/16", 1-1/4", 1-1/2"
<b>SK8H8L</b>	8	1" Drive deep standard set	7/8", 15/16", 1", 1-1/16", 1-1/8", 1-3/16", 1-1/4", 1-1/2"
<b>SK8H9T</b>	9	1" Drive truck service set	13/16" Square; 7/8", 15/16", 1", 1-3/16", 1-1/2" hex; 1-1/16", 1-1/8", 1-1/4" deep thin wall hex
<b>SK8C5T</b>	5	1" Drive truck service set	13/16" square; 33 mm & 1-1/2" deep hex; 1-1/8" and 1-1/4" deep thin wall hex
<b>SK8M4L</b>	4	1" Drive deep metric set	27 mm, 30 mm, 32 mm, 33 mm



SK8H8L

### Individuals

6-PT	Part Number	Output Size	D1 in (mm)	D2 in (mm)	T in (mm)	L in (mm)	Type	Recommended Retaining Ring
STANDARD	S68H34	3/4"	1.38 (35)	2.13 (54)	0.67 (17)	2.28 (58)	A	RR10015S
	S68H1316	13/16"	1.48 (37.5)	2.13 (54)	0.67 (17)	2.28 (58)	A	RR10015S
	S68H78	7/8"	1.54 (39)	2.13 (54)	0.67 (17)	2.28 (58)	A	RR10015S
	S68H1516	15/16"	1.59 (40.5)	2.13 (54)	0.67 (17)	2.28 (58)	A	RR10015S
	S68H1	1"	1.67 (42.5)	2.13 (54)	0.67 (17)	2.36 (60)	A	RR10015S
	S68H1-116	1-1/16"	1.75 (44.5)	2.13 (54)	0.67 (17)	2.36 (60)	A	RR10015S
	S68H1-18	1-1/8"	1.81 (46)	2.13 (54)	0.67 (17)	2.44 (62)	A	RR10015S
	S68H1-316	1-3/16"	1.93 (49)	2.13 (54)	0.67 (17)	2.44 (62)	A	RR10015S
	S68H1-14	1-1/4"	2.13 (54)	2.13 (54)	0.75 (19)	2.48 (63)	A	RR10015S
	S68H1-516	1-5/16"	2.13 (54)	2.13 (54)	0.75 (19)	2.48 (63)	A	PR10015S
	S68H1-38	1-3/8"	2.17 (55)	2.13 (54)	0.75 (19)	2.6 (66)	C	RR10015S
	S68H1-716	1-7/16"	2.22 (56.5)	2.13 (54)	0.75 (19)	2.6 (66)	C	RR10015S
	S68H1-12	1-1/2"	2.32 (59)	2.13 (54)	0.87 (22)	2.6 (66)	C	RR10015S
	S68H1-916	1-9/16"	2.4 (61)	2.13 (54)	0.87 (22)	2.6 (66)	C	RR10015S
	S68H1-58	1-5/8"	2.46 (62.5)	2.13 (54)	0.87 (22)	2.68 (68)	C	RR10015S
	S68H1-1116	1-11/16"	2.56 (65)	2.13 (54)	0.98 (25)	2.76 (70)	C	RR10015S
	S68H1-34	1-3/4"	2.66 (67.5)	2.37 (60.3)	0.98 (25)	2.76 (70)	C	RR10015S
	S68H1-1316	1-13/16"	2.72 (69)	2.37 (60.3)	1.06 (27)	2.83 (72)	C	RR10015
	S68H1-78	1-7/8"	2.76 (70)	2.37 (60.3)	1.06 (27)	2.83 (72)	C	RR10015S
	S68H1-1516	1-15/16"	2.85 (72.5)	2.37 (60.3)	1.06 (27)	2.99 (76)	C	RR10015S
	S68H2	2"	2.91 (74)	2.37 (60.3)	1.06 (27)	2.99 (76)	C	RR10015S

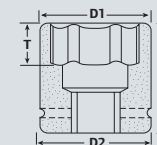



6-PT								
Part Number	Output Size	D1 in (mm)	D2 in (mm)	T in (mm)	L in (mm)	Type	Recommended Retaining Ring	
STANDARD (cont'd)								
S68H2-116	2-1/16"	3.01 (76.5)	2.37 (60.3)	1.22 (31)	3.15 (80)	C	RR10015S	
S68H2-18	2-1/8"	3.11 (79)	2.37 (60.3)	1.22 (31)	3.15 (80)	C	RR10015S	
S68H2-316	2-3/16"	3.15 (80)	2.37 (60.3)	1.22 (31)	3.31 (84)	C	RR10015S	
S68H2-14	2-1/4"	3.25 (82.5)	2.37 (60.3)	1.34 (34)	3.31 (84)	C	RR10015S	
S68H2-516	2-5/16"	3.31 (84)	2.37 (60.3)	1.34 (34)	3.31 (84)	C	RR10015S	
S68H2-38	2-3/8"	3.41 (86.5)	2.37 (60.3)	1.34 (34)	3.46 (88)	C	RR10015S	
S68H2-716	2-7/16"	3.5 (89)	2.37 (60.3)	1.42 (36)	3.46 (88)	C	RR10015S	
S68H2-12	2-1/2"	3.6 (91.5)	2.37 (60.3)	1.42 (36)	3.46 (88)	C	RR10015S	
S68H2-916	2-9/16"	3.64 (92.5)	2.37 (60.3)	1.42 (36)	3.62 (92)	C	RR10015S	
S68H2-58	2-5/8"	3.74 (95)	2.37 (60.3)	1.5 (38)	3.62 (92)	C	RR10015S	
S68H2-1116	2-11/16"	3.8 (96.5)	2.37 (60.3)	1.5 (38)	3.78 (96)	C	RR10015S	
S68H2-34	2-3/4"	63.9 (99)	2.37 (60.3)	1.5 (38)	3.78 (96)	C	RR10015S	
S68H2-1316	2-13/16"	4 (101.5)	2.37 (60.3)	1.61 (41)	3.78 (96)	C	RR10015S	
S68H2-78	2-7/8"	4.04 (102.5)	2.37 (60.3)	1.61 (41)	3.78 (96)	C	RR10015S	
S68H2-1516	2-15/16"	4.11 (104.5)	2.37 (60.3)	1.61 (41)	3.94 (100)	C	RR10015S	
S68H3	3"	4.19 (106.5)	2.37 (60.3)	1.73 (44)	3.94 (100)	C	RR10015S	
S68H3-18	3-1/8"	4.37 (111)	2.37 (60.3)	1.73 (44)	3.94 (100)	C	RR10015S	
S68H3-14	3-1/4"	4.53 (115)	3.39 (86)	1.73 (44)	4.02 (102)	C	RR10025S	
S68H3-38	3-3/8"	4.69 (119)	3.39 (86)	1.93 (49)	4.17 (106)	C	RR10025S	
S68H3-12	3-1/2"	4.88 (124)	3.39 (86)	1.93 (49)	4.25 (108)	C	RR10025S	
S68H3-58	3-5/8"	5 (127)	3.39 (86)	2.09 (53)	4.33 (110)	C	RR10025S	
S68H3-34	3-3/4"	5.12 (130)	3.39 (86)	2.09 (53)	4.33 (110)	C	RR10025S	
S68H3-78	3-7/8"	5.35 (136)	3.74 (95)	2.2 (56)	4.53 (115)	C	RR10025S	
S68H4	4"	5.51 (140)	3.74 (95)	2.2 (56)	4.53 (115)	C	RR10025S	
S68H4-18	4-1/8"	5.63 (143)	3.74 (95)	2.32 (59)	4.72 (120)	C	RR10025S	
S68H4-14	4-1/4"	5.75 (146)	3.74 (95)	2.32 (59)	4.72 (120)	C	RR10025S	
S68H4-38	4-3/8"	5.87 (149)	3.74 (95)	2.4 (61)	4.72 (120)	C	RR10025S	
S68H4-12	4-1/2"	5.98 (152)	3.74 (95)	2.4 (61)	4.72 (120)	C	RR10025S	
S68M19	19 mm	1.38 (35)	2.13 (54)	0.67 (17)	2.28 (58)	A	RR10015S	
S68M21	21 mm	1.48 (37.5)	2.13 (54)	0.67 (17)	2.28 (58)	A	RR10015S	
S68M22	22 mm	1.54 (39)	2.13 (54)	0.67 (17)	2.28 (58)	A	RR10015S	
S68M23	23 mm	1.57 (40)	2.13 (54)	0.67 (17)	2.28 (58)	A	RR10015S	
S68M24	24 mm	1.63 (41.5)	2.13 (54)	0.67 (17)	2.28 (58)	A	RR10015S	
S68M25	25 mm	1.67 (42.5)	2.13 (54)	0.67 (17)	2.36 (60)	A	RR10015S	
S68M26	26 mm	1.73 (44)	2.13 (54)	0.67 (17)	2.36 (60)	A	RR10015S	
S68M27	27 mm	1.77 (45)	2.13 (54)	0.67 (17)	2.36 (60)	A	RR10015S	
S68M28	28 mm	1.83 (46.5)	2.13 (54)	0.67 (17)	2.36 (60)	A	RR10015S	
S68M29	29 mm	1.87 (47.5)	2.13 (54)	0.75 (19)	2.44 (62)	A	RR10015S	
S68M30	30 mm	1.93 (49)	2.13 (54)	0.75 (19)	2.44 (62)	A	RR10015S	
S68M31	31 mm	1.97 (50)	2.13 (54)	0.75 (19)	2.44 (62)	A	RR10015S	

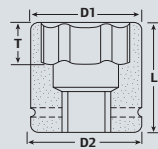

6-PT								
Part Number	Output Size	D1 in (mm)	D2 in (mm)	T in (mm)	L in (mm)	Type	Recommended Retaining Ring	
STANDARD (cont'd)								
S68M32	32 mm	2.03 (51.5)	2.13 (54)	0.75 (19)	2.48 (63)	A	RR10015S	
S68M33	33 mm	2.07 (52.5)	2.13 (54)	0.83 (21)	2.48 (63)	A	RR10015S	
S68M34	34 mm	2.13 (54)	2.13 (54)	0.83 (21)	2.48 (63)	B	RR10015S	
S68M35	35 mm	2.17 (55)	2.13 (54)	0.83 (21)	2.6 (66)	C	RR10015S	
S68M36	36 mm	2.22 (56.5)	2.13 (54)	0.91 (23)	2.6 (66)	C	RR10015S	
S68M38	38 mm	2.32 (59)	2.13 (54)	0.91 (23)	2.6 (66)	C	RR10015S	
S68M40	40 mm	2.4 (61)	2.13 (54)	0.91 (23)	2.6 (66)	C	RR10015S	
S68M41	41 mm	2.46 (62.5)	2.13 (54)	0.98 (25)	2.68 (68)	C	RR10015S	
S68M42	42 mm	62.52 (64)	2.13 (54)	0.98 (25)	2.68 (68)	C	RR10015S	
S68M43	43 mm	2.56 (65)	2.13 (54)	0.98 (25)	2.76 (70)	C	RR10015S	
S68M45	45 mm	2.66 (67.5)	2.13 (54)	0.98 (25)	2.76 (70)	C	RR10015S	
S68M46	46 mm	2.72 (69)	2.13 (54)	1.14 (29)	2.83 (72)	C	RR10015S	
S68M48	48 mm	2.81 (71.5)	2.13 (54)	1.14 (29)	2.99 (76)	C	RR10015S	
S68M50	50 mm	2.91 (74)	2.13 (54)	1.22 (31)	2.99 (76)	C	RR10015S	
S68M52	52 mm	3.01 (76.5)	2.13 (54)	1.22 (31)	3.15 (80)	C	RR10015S	
S68M54	54 mm	3.11 (79)	2.13 (54)	1.22 (31)	3.15 (80)	C	RR10015S	
S68M55	55 mm	3.15 (80)	2.13 (54)	1.34 (34)	3.31 (84)	C	RR10015S	
S68M56	56 mm	3.21 (81.5)	2.13 (54)	1.34 (34)	3.31 (84)	C	RR10015S	
S68M58	58 mm	3.31 (84)	2.13 (54)	1.34 (34)	3.31 (84)	C	RR10015S	
S68M60	60 mm	3.41 (86.5)	2.13 (54)	1.38 (35)	3.46 (88)	C	RR10015S	
S68M65	65 mm	3.64 (92.5)	2.13 (54)	1.38 (35)	3.62 (92)	C	RR10015S	
S68M70	70 mm	3.9 (99)	2.13 (54)	1.38 (35)	3.78 (96)	C	RR10015S	
S68M75	75 mm	4.13 (105)	2.37 (60.3)	1.38 (35)	4.02 (102)	C	RR10015S	
S68M80	80 mm	4.39 (111.5)	2.37 (60.3)	1.38 (35)	4.02 (102)	C	RR10015S	
S68M85	85 mm	4.63 (117.5)	3.39 (86)	1.38 (35)	4.17 (106)	C	RR10025S	
S68M90	90 mm	4.88 (124)	3.39 (86)	1.38 (35)	4.25 (108)	C	RR10025S	
S68M95	95 mm	5.12 (130)	3.39 (86)	1.38 (35)	4.33 (110)	C	RR10025S	
DEEP								
S68H34L	3/4"	1.38 (35)	2.13 (54)	0.98 (25)	3.54 (90)	A	RR10015S	
S68H1316L	13/16"	1.46 (37)	2.13 (54)	0.98 (25)	3.54 (90)	A	RR10015S	
S68H78L	7/8"	1.54 (39)	2.13 (54)	0.98 (25)	3.54 (90)	A	RR10015S	
S68H1516L	15/16"	1.59 (40.5)	2.13 (54)	0.98 (25)	3.54 (90)	A	RR10015S	
S68H1L	1"	1.67 (42.5)	2.13 (54)	0.98 (25)	3.54 (90)	A	RR10015S	
S68H1-116L	1-1/16"	1.75 (44.5)	2.13 (54)	0.98 (25)	3.54 (90)	A	RR10015S	
S68H1-18L	1-1/8"	1.81 (46)	2.13 (54)	0.98 (25)	3.54 (90)	A	RR10015S	
S68H1-316L	1-3/16"	1.93 (49)	2.13 (54)	0.98 (25)	3.54 (90)	A	RR10015S	
S68H1-14L	1-1/4"	2.03 (51.5)	2.13 (54)	0.98 (25)	3.54 (90)	A	RR10015S	
S68H1-516L	1-5/16"	2.13 (54)	2.13 (54)	0.98 (25)	3.54 (90)	B	RR10015S	
S68H1-38L	1-3/8"	2.17 (55)	2.13 (54)	0.98 (25)	3.54 (90)	C	RR10015S	
S68H1-716L	1-7/16"	2.22 (56.5)	2.13 (54)	0.98 (25)	3.54 (90)	C	RR10015S	

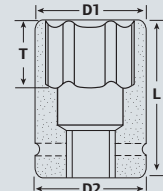

6-PT		Part Number	Output Size	D1 in (mm)	D2 in (mm)	T in (mm)	L in (mm)	Type	Recommended Retaining Ring
DEEP (cont'd)									
	S68H1-12L	1-1/2"	2.32 (59)	2.13 (54)	0.98 (25)	3.54 (90)	C	RR10015S	
	S68H1-916L	1-9/16"	2.4 (61)	2.13 (54)	0.98 (25)	3.54 (90)	C	RR10015S	
	S68H1-58L	1-5/8"	2.46 (62.5)	2.13 (54)	0.98 (25)	3.54 (90)	C	RR10015S	
	S68H1-1116L	1-11/16"	2.56 (65)	2.13 (54)	0.98 (25)	3.54 (90)	C	RR10015S	
	S68H1-34L	1-3/4"	2.66 (67.5)	2.37 (60.3)	1.22 (31)	3.94 (100)	C	RR10015S	
	S68H1-1316L	1-13/16"	2.72 (69)	2.37 (60.3)	1.22 (31)	3.94 (100)	C	RR10015S	
	S68H1-78L	1-7/8"	2.76 (70)	2.37 (60.3)	1.22 (31)	3.94 (100)	C	RR10015S	
	S68H1-1516L	1-15/16"	2.85 (72.5)	2.37 (60.3)	1.22 (31)	3.94 (100)	C	RR10015S	
	S68H2L	2"	2.91 (74)	2.37 (60.3)	1.22 (31)	3.94 (100)	C	RR10015S	
	S68H2-116L	2-1/16"	3.01 (76.5)	2.37 (60.3)	1.22 (31)	3.94 (100)	C	RR10015S	
S68H2-18L	2-1/8"	3.11 (79)	2.37 (60.3)	1.22 (31)	4.25 (108)	C	RR10015S		
S68H2-316L	2-3/16"	3.15 (80)	2.37 (60.3)	1.22 (31)	4.25 (108)	C	RR10015S		
S68H2-14L	2-1/4"	3.25 (82.5)	2.37 (60.3)	1.42 (36)	4.25 (108)	C	RR10015S		
S68H2-516L	2-5/16"	3.31 (84)	2.37 (60.3)	1.42 (36)	4.25 (108)	C	RR10015S		
S68H2-38L	2-3/8"	3.41 (86.5)	2.37 (60.3)	1.42 (36)	4.25 (108)	C	RR10015S		
S68H2-716L	2-7/16"	3.5 (89)	2.37 (60.3)	1.42 (36)	4.25 (108)	C	RR10015S		
S68H2-12L	2-1/2"	3.6 (91.5)	2.37 (60.3)	1.42 (36)	4.72 (120)	C	RR10015S		
S68H2-916L	2-9/16"	3.64 (92.5)	2.37 (60.3)	1.42 (36)	4.72 (120)	C	RR10015S		
S68H2-58L	2-5/8"	3.74 (95)	2.37 (60.3)	1.73 (44)	4.72 (120)	C	RR10015S		
S68H2-1116L	2-11/16"	3.8 (96.5)	2.37 (60.3)	1.73 (44)	4.72 (120)	C	RR10015S		
S68H2-34L	2-3/4"	3.9 (99)	2.37 (60.3)	1.73 (44)	4.92 (125)	C	RR10015S		
S68H2-1316L	2-13/16"	4 (101.5)	2.37 (60.3)	1.73 (44)	4.92 (125)	C	RR10015S		
S68H2-78L	2-7/8"	4.04 (102.5)	2.37 (60.3)	1.73 (44)	4.92 (125)	C	RR10015S		
S68H2-1516L	2-15/16"	4.11 (104.5)	2.37 (60.3)	1.73 (44)	4.92 (125)	C	RR10015S		
S68H3L	3"	4.19 (106.5)	2.37 (60.3)	1.73 (44)	4.92 (125)	C	RR10015S		
S68H3-18L	3-1/8"	4.39 (111.5)	2.37 (60.3)	1.73 (44)	4.92 (125)	C	RR10015S		
S68H3-14L	3-1/4"	4.45 (113)	3.39 (86)	1.73 (44)	5.31 (135)	C	RR10025S		
S68H3-38L	3-3/8"	4.53 (115)	3.39 (86)	2.2 (56)	5.31 (135)	C	RR10025S		
S68H3-12L	3-1/2"	4.69 (119)	3.39 (86)	2.2 (56)	5.31 (135)	C	RR10025S		
S68H3-58L	3-5/8"	5 (127)	3.39 (86)	2.2 (56)	5.51 (140)	C	RR10025S		
S68H3-34L	3-3/4"	5.12 (130)	3.39 (86)	2.2 (56)	5.51 (140)	C	RR10025S		
S68H3-78L	3-7/8"	5.35 (136)	3.74 (95)	2.2 (56)	5.51 (140)	C	RR10025S		
S68H4L	4"	5.51 (140)	3.74 (95)	2.2 (56)	6.1 (155)	C	RR10025S		
S68H4-18L	4-1/8"	5.63 (143)	3.74 (95)	2.4 (61)	6.1 (155)	C	RR10025S		
S68H4-14L	4-1/4"	5.75 (146)	3.74 (95)	2.4 (61)	6.1 (155)	C	RR10025S		
S68H4-38L	4-3/8"	5.87 (149)	3.74 (95)	2.4 (61)	6.1 (155)	C	RR10025S		
S68H4-12L	4-1/2"	5.98 (152)	3.74 (95)	2.4 (61)	6.1 (155)	C	RR10025S		
S68M19L	19 mm	1.38 (35)	2.13 (54)	0.98 (25)	3.54 (90)	A	RR10015S		
S68M21L	21 mm	1.48 (37.5)	2.13 (54)	0.98 (25)	3.54 (90)	A	RR10015S		
S68M22L	22 mm	1.54 (39)	2.13 (54)	0.98 (25)	3.54 (90)	A	RR10015S		

6-PT		Part Number	Output Size	D1 in (mm)	D2 in (mm)	T in (mm)	L in (mm)	Type	Recommended Retaining Ring
DEEP (cont'd)									
	S68M23L	23 mm	1.57 (40)	2.13 (54)	0.98 (25)	3.54 (90)	A	RR10015S	
	S68M24L	24 mm	1.63 (41.5)	2.13 (54)	0.98 (25)	3.54 (90)	A	RR10015S	
	S68M25L	25 mm	1.67 (42.5)	2.13 (54)	0.98 (25)	3.54 (90)	A	RR10015S	
	S68M26L	26 mm	1.73 (44)	2.13 (54)	0.98 (25)	3.54 (90)	A	RR10015S	
	S68M27L	27 mm	1.77 (45)	2.13 (54)	0.98 (25)	3.54 (90)	A	RR10015S	
	S68M28L	28 mm	1.83 (46.5)	2.13 (54)	0.98 (25)	3.54 (90)	A	RR10015S	
	S68M29L	29 mm	1.87 (47.5)	2.13 (54)	0.98 (25)	3.54 (90)	A	RR10015S	
	S68M30L	30 mm	1.93 (49)	2.13 (54)	0.98 (25)	3.54 (90)	A	RR10015S	
	S68M31L	31 mm	1.97 (50)	2.13 (54)	0.98 (25)	3.54 (90)	A	RR10015S	
	S68M32L	32 mm	2.03 (51.5)	2.13 (54)	0.98 (25)	3.54 (90)	A	RR10015S	
	S68M33L	33 mm	2.07 (52.5)	2.13 (54)	0.98 (25)	3.54 (90)	A	RR10015S	
	S68M34L	34 mm	2.13 (54)	2.13 (54)	0.98 (25)	3.54 (90)	B	RR10015S	
	S68M35L	35 mm	2.17 (55)	2.13 (54)	0.98 (25)	3.54 (90)	C	RR10015S	
	S68M36L	36 mm	2.22 (56.5)	2.13 (54)	0.98 (25)	3.54 (90)	C	RR10015S	
	S68M37L	37 mm	2.28 (58)	2.13 (54)	0.98 (25)	3.54 (90)	C	RR10015S	
	S68M38L	38 mm	2.32 (59)	2.13 (54)	0.98 (25)	3.54 (90)	C	RR10015S	
	S68M40L	40 mm	2.4 (61)	2.13 (54)	0.98 (25)	3.54 (90)	C	RR10015S	
	S68M41L	41 mm	2.46 (62.5)	2.13 (54)	0.98 (25)	3.54 (90)	C	RR10015S	
	S68M42L	42 mm	2.52 (64)	2.13 (54)	0.98 (25)	3.54 (90)	C	RR10015S	
	S68M43L	43 mm	2.56 (65)	2.13 (54)	0.98 (25)	3.54 (90)	C	RR10015S	
	S68M45L	45 mm	2.66 (67.5)	2.13 (54)	1.18 (30)	3.94 (100)	C	RR10015S	
	S68M46L	46 mm	2.72 (69)	2.13 (54)	1.18 (30)	3.94 (100)	C	RR10015S	
	S68M48L	48 mm	2.81 (71.5)	2.13 (54)	1.18 (30)	3.94 (100)	C	RR10015S	
	S68M50L	50 mm	2.91 (74)	2.13 (54)	1.18 (30)	3.94 (100)	C	RR10015S	
	S68M52L	52 mm	3.01 (76.5)	2.13 (54)	1.18 (30)	3.94 (100)	C	RR10015S	
	S68M54L	54 mm	3.11 (79)	2.13 (54)	1.38 (35)	4.25 (108)	C	RR10015S	
	S68M55L	55 mm	3.15 (80)	2.13 (54)	1.38 (35)	4.25 (108)	C	RR10015S	
	S68M56L	56 mm	3.21 (81.5)	2.13 (54)	1.38 (35)	4.25 (108)	C	RR10015S	
	S68M58L	58 mm	3.31 (84)	2.13 (54)	1.38 (35)	4.25 (108)	C	RR10015S	
	S68M60L	60 mm	3.41 (86.5)	2.13 (54)	1.38 (35)	4.25 (108)	C	RR10015S	
	S68M65L	65 mm	3.64 (92.5)	2.13 (54)	1.38 (35)	4.72 (120)	C	RR10015S	
	S68M70L	70 mm	3.9 (99)	2.13 (54)	1.38 (35)	4.92 (125)	C	RR10015S	
	S68M75L	75 mm	4.13 (105)	2.37 (60.3)	1.38 (35)	4.92 (125)	C	RR10015S	
	S68M80L	80 mm	4.39 (111.5)	2.37 (60.3)	1.38 (35)	4.92 (125)	C	RR10015S	
	S68M85L	85 mm	4.53 (115)	3.39 (86)	1.38 (35)	5.31 (135)	C	RR10025S	
	S68M90L	90 mm	4.88 (124)	3.39 (86)	1.38 (35)	5.31 (135)	C	RR10025S	
	S68M95L	95 mm	5.12 (130)	3.39 (86)	1.38 (35)	5.51 (140)	C	RR10025S	

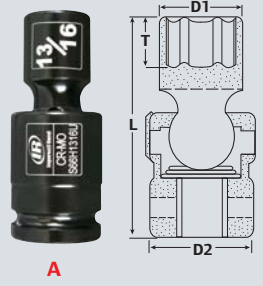
6-PT	Part Number	Output Size	D1 in (mm)	D2 in (mm)	T in (mm)	L in (mm)	Type	Recommended Retaining Ring
UNIVERSAL								
	S68H78U	7/8"	1.54 (39)	2.13 (54)	0.75 (19)	5 (127)	A	RR10015S
	S68H1516U	15/16"	1.61 (41)	2.13 (54)	0.75 (19)	5.2 (132)	A	RR10015S
	S68H1-116U	1-1/16"	1.77 (45)	2.13 (54)	0.75 (19)	5.2 (132)	A	RR10015S
	S68H1-18U	1-1/8"	1.89 (48)	2.13 (54)	0.75 (19)	5.2 (132)	A	RR10015S
	S68H1-316U	1-3/16"	1.93 (49)	2.13 (54)	0.75 (19)	5.2 (132)	A	RR10015S
	S68H1-14U	1-1/4"	2.01 (51)	2.13 (54)	0.75 (19)	5.2 (132)	A	RR10015S
	S68H1-516U	1-5/16"	2.09 (53)	2.13 (54)	0.75 (19)	5.2 (132)	A	RR10015S
	S68H1-38U	1-3/8"	2.17 (55)	2.13 (54)	0.75 (19)	5.2 (132)	A	RR10015S
	S68H1-716U	1-7/16"	2.28 (58)	2.13 (54)	0.75 (19)	5.2 (132)	A	RR10015S
	S68H1-12U	1-1/2"	2.32 (59)	2.13 (54)	0.98 (25)	5.39 (137)	A	RR10015S
	S68H1-916U	1-9/16"	2.4 (61)	2.13 (54)	0.98 (25)	5.39 (137)	A	RR10015S
	S68H1-58U	1-5/8"	2.48 (63)	2.13 (54)	0.98 (25)	5.39 (137)	A	RR10015S
	S68H1-1116U	1-11/16"	2.56 (65)	2.13 (54)	0.98 (25)	5.39 (137)	A	RR10015S
	S68H1-34U	1-3/4"	2.64 (67)	2.13 (54)	0.98 (25)	5.39 (137)	A	RR10015S
	S68H1-1316U	1-13/16"	2.72 (69)	2.13 (54)	1.06 (27)	5.59 (142)	A	RR10015S
	S68H1-78U	1-7/8"	2.8 (71)	2.13 (54)	1.06 (27)	5.59 (142)	A	RR10015S
	S68H1-1516U	1-15/16"	2.83 (72)	2.13 (54)	1.06 (27)	5.59 (142)	A	RR10015S
	S68H2U	2"	2.99 (76)	2.13 (54)	1.06 (27)	5.59 (142)	A	RR10015S
	S68M24U	24 mm	1.61 (41)	2.13 (54)	0.67 (17)	5.2 (132)	A	RR10015S
	S68M26U	26 mm	1.73 (44)	2.13 (54)	0.67 (17)	5.2 (132)	A	RR10015S
	S68M27U	27 mm	1.77 (45)	2.13 (54)	0.67 (17)	5.2 (132)	A	RR10015S
	S68M29U	29 mm	1.89 (48)	2.13 (54)	0.67 (17)	5.2 (132)	A	RR10015S
	S68M30U	30 mm	1.93 (49)	2.13 (54)	0.67 (17)	5.2 (132)	A	RR10015S
	S68M32U	32 mm	2.01 (51)	2.13 (54)	0.87 (22)	5.2 (132)	A	RR10015S
	S68M33U	33 mm	2.09 (53)	2.13 (54)	0.87 (22)	5.2 (132)	A	RR10015S
	S68M34U	34 mm	2.13 (54)	2.13 (54)	0.87 (22)	5.2 (132)	A	RR10015S
	S68M35U	35 mm	2.17 (55)	2.13 (54)	0.87 (22)	5.2 (132)	A	RR10015S
	S68M36U	36 mm	2.2 (56)	2.13 (54)	0.87 (22)	5.2 (132)	A	RR10015S
	S68M38U	38 mm	2.32 (59)	2.13 (54)	0.98 (25)	5.39 (137)	A	RR10015S
	S68M41U	41 mm	2.48 (63)	2.13 (54)	0.98 (25)	5.39 (137)	A	RR10015S
S68M42U	42 mm	2.52 (64)	2.13 (54)	0.98 (25)	5.39 (137)	A	RR10015S	
S68M43U	43 mm	2.56 (65)	2.13 (54)	0.98 (25)	5.39 (137)	A	RR10015S	
S68M44U	44 mm	2.64 (67)	2.13 (54)	0.98 (25)	5.39 (137)	A	RR10015S	
S68M45U	45 mm	2.68 (68)	2.13 (54)	1.06 (27)	5.59 (142)	A	RR10015S	
S68M46U	46 mm	2.72 (69)	2.13 (54)	1.06 (27)	5.59 (142)	A	RR10015S	
S68M47U	47 mm	2.76 (70)	2.13 (54)	1.06 (27)	5.59 (142)	A	RR10015S	
S68M48U	48 mm	2.8 (71)	2.13 (54)	1.06 (27)	5.59 (142)	A	RR10015S	
S68M50U	50 mm	2.91 (74)	2.13 (54)	1.06 (27)	5.59 (142)	A	RR10015S	

## Accessories

	Description	Output Size	Recommended Retaining Ring
<b>A8F6M</b>	1" female to 3/4" male adapter	3/4"	RR10015S
<b>A8F12M</b>	1" female to 1-1/2" male adapter	1-1/2"	RR10015S
<b>A8F55M</b>	1" female to #5 spline male adapter	#5 Spline	RR10015S
<b>J8</b>	Universal joint	1"	RR10015S
<b>E83H</b>	3" Extension	1"	RR10015S
<b>E87H</b>	7" Extension	1"	RR10015S
<b>E810H</b>	10" Extension	1"	RR10015S
<b>E813H</b>	13" Extension	1"	RR10015S





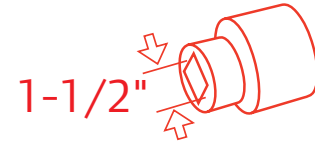

# 1-1/2" Square Drive Impact Sockets

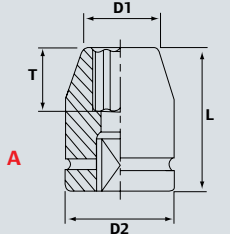
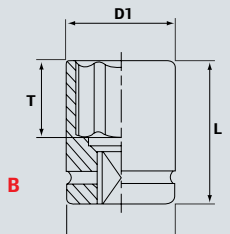
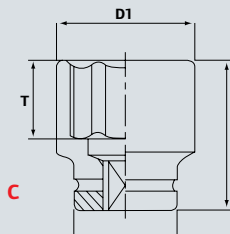

## Individuals

6-PT	Part Number	Output Size	D1 in (mm)	D2 in (mm)	T in (mm)	L in (mm)	Type	Recommended Retaining Ring
STANDARD								
   	S612H1-316	1-3/16"	2.2 (56)	3.39 (86)	0.83 (21)	3.07 (78)	A	RR10025S
	S612H1-14	1-1/4"	2.28 (58)	3.39 (86)	0.87 (22)	3.07 (78)	A	RR10025S
	S612H1-516	1-5/16"	2.36 (60)	3.39 (86)	0.87 (22)	3.07 (78)	A	RR10025S
	S612H1-38	1-3/8"	2.52 (64)	3.39 (86)	0.87 (22)	3.07 (78)	A	RR10025S
	S612H1-716	1-7/16"	2.52 (64)	3.39 (86)	0.94 (24)	3.07 (78)	A	RR10025S
	S612H1-12	1-1/2"	2.6 (66)	3.39 (86)	1.02 (26)	3.15 (80)	A	RR10025S
	S612H1-916	1-9/16"	2.68 (68)	3.39 (86)	1.1 (28)	3.15 (80)	A	RR10025S
	S612H1-58	1-5/8"	2.76 (70)	3.39 (86)	1.1 (28)	3.15 (80)	A	RR10025S
	S612H1-1116	1-11/16"	2.87 (73)	3.39 (86)	1.1 (28)	3.23 (82)	A	RR10025S
	S612H1-34	1-3/4"	2.95 (75)	3.39 (86)	1.18 (30)	3.31 (84)	A	RR10025S
	S612H1-1316	1-13/16"	2.99 (76)	3.39 (86)	1.18 (30)	3.31 (84)	A	RR10025S
	S612H1-78	1-7/8"	3.07 (78)	3.39 (86)	1.26 (32)	3.43 (87)	A	RR10025S
	S612H1-1516	1-15/16"	3.15 (80)	3.39 (86)	1.26 (32)	3.43 (87)	A	RR10025S
	S612H2	2"	3.23 (82)	3.39 (86)	1.26 (32)	3.43 (87)	A	RR10025S
	S612H2-116	2-1/16"	3.27 (83)	3.39 (86)	1.34 (34)	3.43 (87)	A	RR10025S
	S612H2-18	2-1/8"	3.39 (86)	3.39 (86)	1.46 (37)	3.54 (90)	B	RR10025S
	S612H2-316	2-3/16"	3.46 (88)	3.39 (86)	1.46 (37)	3.54 (90)	C	RR10025S
	S612H2-14	2-1/4"	3.54 (90)	3.39 (86)	1.54 (39)	3.74 (95)	C	RR10025S
	S612H2-516	2-5/16"	3.66 (93)	3.39 (86)	1.54 (39)	3.74 (95)	C	RR10025S
	S612H2-38	2-3/8"	3.7 (94)	3.39 (86)	1.54 (39)	3.74 (95)	C	RR10025S
	S612H2-716	2-7/16"	3.78 (96)	3.39 (86)	1.65 (42)	3.94 (100)	C	RR10025S
	S612H2-12	2-1/2"	3.86 (98)	3.39 (86)	1.65 (42)	3.94 (100)	C	RR10025S
	S612H2-916	2-9/16"	3.94 (100)	3.39 (86)	1.65 (42)	3.94 (100)	C	RR10025S
	S612H2-58	2-5/8"	4.02 (102)	3.39 (86)	1.81 (46)	4.13 (105)	C	RR10025S
	S612H2-1116	2-11/16"	4.09 (104)	3.39 (86)	1.81 (46)	4.13 (105)	C	RR10025S
	S612H2-34	2-3/4"	4.17 (106)	3.39 (86)	1.81 (46)	4.13 (105)	C	RR10025S
	S612H2-1316	2-13/16"	4.25 (108)	3.39 (86)	1.93 (49)	4.25 (108)	C	RR10025S
	S612H2-78	2-7/8"	4.33 (110)	3.39 (86)	1.93 (49)	4.25 (108)	C	RR10025S
	S612H2-1516	2-15/16"	4.41 (112)	3.39 (86)	1.93 (49)	4.25 (108)	C	RR10025S
	S612H3	3"	4.45 (113)	3.39 (86)	1.93 (49)	4.25 (108)	C	RR10025S
	S612H3-116	3-1/16"	4.53 (115)	3.39 (86)	2.09 (53)	4.53 (115)	C	RR10025S
	S612H3-18	3-1/8"	4.65 (118)	3.39 (86)	2.09 (53)	4.53 (115)	C	RR10025S
	S612H3-316	3-3/16"	4.72 (120)	3.39 (86)	2.09 (53)	4.53 (115)	C	RR10025S
S612H3-14	3-1/4"	4.8 (122)	3.39 (86)	2.09 (53)	4.53 (115)	C	RR10025S	
S612H3-516	3-5/16"	4.88 (124)	3.39 (86)	2.2 (56)	4.65 (118)	C	RR10025S	

6-PT	Part Number	Output Size	D1 in (mm)	D2 in (mm)	T in (mm)	L in (mm)	Type	Recommended Retaining Ring
STANDARD (cont'd)								
	S612H3-38	3-3/8"	4.96 (126)	3.39 (86)	2.2 (56)	4.65 (118)	C	RR10025S
	S612H3-716	3-7/16"	5.04 (128)	3.39 (86)	2.2 (56)	4.65 (118)	C	RR10025S
	S612H3-12	3-1/2"	5.08 (129)	3.39 (86)	2.32 (59)	4.84 (123)	C	RR10025S
	S612H3-916	3-9/16"	5.16 (131)	3.39 (86)	2.32 (59)	4.84 (123)	C	RR10025S
	S612H3-58	3-5/8"	5.24 (133)	3.39 (86)	2.32 (59)	4.84 (123)	C	RR10025S
	S612H3-1116	3-11/16"	5.31 (135)	3.39 (86)	2.4 (61)	4.84 (123)	C	RR10025S
	S612H3-34	3-3/4"	5.39 (137)	3.74 (95)	2.4 (61)	4.84 (123)	C	RR10025S
	S612H3-1316	3-13/16"	5.39 (137)	3.74 (95)	2.56 (65)	5.12 (130)	C	RR10025S
	S612H3-78	3-7/8"	5.67 (144)	3.74 (95)	2.56 (65)	5.12 (130)	C	RR10025S
	S612H3-1516	3-15/16"	5.67 (144)	3.74 (95)	2.56 (65)	5.12 (130)	C	RR10025S
	S612H4	4"	5.79 (147)	3.74 (95)	2.56 (65)	5.12 (130)	C	RR10025S
	S612H4-116	4-1/16"	5.79 (147)	3.74 (95)	2.68 (68)	5.12 (130)	C	RR10025S
	S612H4-18	4-1/8"	6.06 (154)	3.74 (95)	2.68 (68)	5.12 (130)	C	RR10025S
	S612H4-316	4-3/16"	6.06 (154)	3.74 (95)	2.68 (68)	5.12 (130)	C	RR10025S
	S612H4-14	4-1/4"	6.06 (154)	3.74 (95)	2.83 (72)	5.31 (135)	C	RR10025S
	S612H4-516	4-5/16"	6.18 (157)	3.74 (95)	2.83 (72)	5.31 (135)	C	RR10025S
	S612H4-38	4-3/8"	6.18 (157)	3.74 (95)	2.83 (72)	5.31 (135)	C	RR10025S
	S612H4-716	4-7/16"	6.18 (157)	3.74 (95)	2.83 (72)	5.31 (135)	C	RR10025S
	S612H4-12	4-1/2"	6.46 (164)	3.74 (95)	3.03 (77)	5.51 (140)	C	RR10025S
	S612H4-58	4-5/8"	6.46 (164)	3.74 (95)	3.03 (77)	5.51 (140)	C	RR10025S
	S612H4-34	4-3/4"	6.57 (167)	3.74 (95)	3.03 (77)	5.51 (140)	C	RR10025S
	S612M30	30 mm	2.2 (56)	3.39 (86)	0.83 (21)	3.07 (78)	A	RR10025S
	S612M32	32 mm	2.28 (58)	3.39 (86)	0.87 (22)	3.07 (78)	A	RR10025S
	S612M35	35 mm	2.52 (64)	3.39 (86)	0.87 (22)	3.07 (78)	A	RR10025S
	S612M36	36 mm	2.52 (64)	3.39 (86)	0.94 (24)	3.07 (78)	A	RR10025S
	S612M38	38 mm	2.6 (66)	3.39 (86)	1.02 (26)	3.15 (80)	A	RR10025S
	S612M41	41 mm	2.76 (70)	3.39 (86)	1.1 (28)	3.15 (80)	A	RR10025S
	S612M46	46 mm	2.99 (76)	3.39 (86)	1.18 (30)	3.31 (84)	A	RR10025S
	S612M50	50 mm	3.19 (81)	3.39 (86)	1.26 (32)	3.43 (87)	A	RR10025S
	S612M54	54 mm	3.39 (86)	3.39 (86)	1.46 (37)	3.54 (90)	B	RR10025S
	S612M55	55 mm	3.43 (87)	3.39 (86)	1.46 (37)	3.54 (90)	C	RR10025S
	S612M58	58 mm	3.62 (92)	3.39 (86)	1.54 (39)	3.74 (95)	C	RR10025S
	S612M60	60 mm	3.7 (94)	3.39 (86)	1.54 (39)	3.74 (95)	C	RR10025S
	S612M62	62 mm	3.78 (96)	3.39 (86)	1.65 (42)	3.94 (100)	C	RR10025S
	S612M65	65 mm	3.94 (100)	3.39 (86)	1.65 (42)	3.94 (100)	C	RR10025S
	S612M68	68 mm	4.09 (104)	3.39 (86)	1.81 (46)	4.13 (105)	C	RR10025S
	S612M70	70 mm	4.17 (106)	3.39 (86)	1.81 (46)	4.13 (105)	C	RR10025S
	S612M73	73 mm	4.33 (110)	3.39 (86)	1.93 (49)	4.25 (108)	C	RR10025S
	S612M75	75 mm	4.41 (112)	3.39 (86)	1.93 (49)	4.25 (108)	C	RR10025S

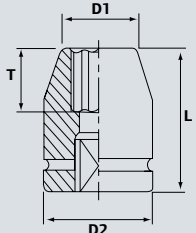
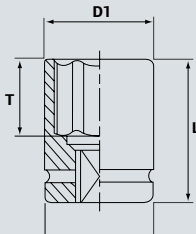
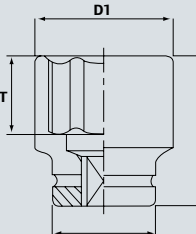
6-PT								
Part Number	Output Size	D1 in (mm)	D2 in (mm)	T in (mm)	L in (mm)	Type	Recommended Retaining Ring	
<b>STANDARD (cont'd)</b>								
S612M78	78 mm	4.53 (115)	3.39 (86)	2.09 (53)	4.53 (115)	C	RR10025S	
S612M80	80 mm	4.69 (119)	3.39 (86)	2.09 (53)	4.53 (115)	C	RR10025S	
S612M85	85 mm	4.92 (125)	3.39 (86)	2.2 (56)	4.65 (118)	C	RR10025S	
S612M90	90 mm	5.16 (131)	3.39 (86)	2.32 (59)	4.84 (123)	C	RR10025S	
S612M95	95 mm	5.39 (137)	3.74 (95)	2.4 (61)	4.84 (123)	C	RR10025S	
S612M100	100 mm	5.67 (144)	3.74 (95)	2.56 (65)	5.12 (130)	C	RR10025S	
S612M105	105 mm	6.06 (154)	3.74 (95)	2.68 (68)	5.12 (130)	C	RR10025S	
S612M110	110 mm	6.18 (157)	3.74 (95)	2.83 (72)	5.31 (135)	C	RR10025S	
S612M115	115 mm	6.46 (164)	3.74 (95)	3.03 (77)	5.51 (140)	C	RR10025S	
S612M120	120 mm	6.57 (167)	3.74 (95)	3.03 (77)	5.51 (140)	C	RR10025S	
S612M125	125 mm	6.85 (174)	5 (127)	3.03 (77)	5.51 (140)	C	RR10035S	
<b>DEEP</b>								
								
								
								
								
S612H1-58L	1-5/8"	2.76 (70)	3.39 (86)	1.1 (28)	4.53 (115)	A	RR10025S	
S612H1-1116L	1-11/16"	2.87 (73)	3.39 (86)	1.1 (28)	4.53 (115)	A	RR10025S	
S612H1-34L	1-3/4"	2.95 (75)	3.39 (86)	1.18 (30)	4.53 (115)	A	RR10025S	
S612H1-1316L	1-13/16"	2.99 (76)	3.39 (86)	1.18 (30)	4.53 (115)	A	RR10025S	
S612H1-78L	1-7/8"	3.07 (78)	3.39 (86)	1.26 (32)	4.53 (115)	A	RR10025S	
S612H1-1516L	1-15/16"	3.15 (80)	3.39 (86)	1.26 (32)	4.53 (115)	A	RR10025S	
S612H2L	2"	3.23 (82)	3.39 (86)	1.34 (34)	5.31 (135)	A	RR10025S	
S612H2-116L	2-1/16"	3.27 (83)	3.39 (86)	1.34 (34)	5.51 (140)	A	RR10025S	
S612H2-18L	2-1/8"	3.39 (86)	3.39 (86)	1.46 (37)	5.51 (140)	B	RR10025S	
S612H2-316L	2-3/16"	3.46 (88)	3.39 (86)	1.46 (37)	5.51 (140)	C	RR10025S	
S612H2-14L	2-1/4"	3.54 (90)	3.39 (86)	1.54 (39)	5.91 (150)	C	RR10025S	
S612H2-516L	2-5/16"	3.66 (93)	3.39 (86)	1.54 (39)	5.91 (150)	C	RR10025S	
S612H2-38L	2-3/8"	3.7 (94)	3.39 (86)	1.54 (39)	5.91 (150)	C	RR10025S	
S612H2-716L	2-7/16"	3.78 (96)	3.39 (86)	1.65 (42)	5.91 (150)	C	RR10025S	
S612H2-12L	2-1/2"	3.86 (98)	3.39 (86)	1.65 (42)	5.91 (150)	C	RR10025S	
S612H2-916L	2-9/16"	3.94 (100)	3.39 (86)	1.65 (42)	5.91 (150)	C	RR10025S	
S612H2-58L	2-5/8"	4.02 (102)	3.39 (86)	1.81 (46)	5.91 (150)	C	RR10025S	
S612H2-1116L	2-11/16"	4.09 (104)	3.39 (86)	1.81 (46)	5.91 (150)	C	RR10025S	
S612H2-34L	2-3/4"	4.17 (106)	3.39 (86)	1.81 (46)	6.3 (160)	C	RR10025S	
S612H2-1316L	2-13/16"	4.25 (108)	3.39 (86)	1.93 (49)	6.3 (160)	C	RR10025S	
S612H2-78L	2-7/8"	4.33 (110)	3.39 (86)	1.93 (49)	6.3 (160)	C	RR10025S	
S612H2-1516L	2-15/16"	4.41 (112)	3.39 (86)	1.93 (49)	6.69 (170)	C	RR10025S	
S612H3L	3"	4.45 (113)	3.39 (86)	1.93 (49)	6.69 (170)	C	RR10025S	
S612H3-116L	3-1/16"	4.53 (115)	3.39 (86)	2.09 (53)	6.69 (170)	C	RR10025S	
S612H3-18L	3-1/8"	4.65 (118)	3.39 (86)	2.09 (53)	6.69 (170)	C	RR10025S	
S612H3-38L	3-3/8"	4.96 (126)	3.39 (86)	2.2 (56)	6.69 (170)	C	RR10025S	
S612H3-12L	3-1/2"	5.08 (129)	3.39 (86)	2.32 (59)	6.69 (170)	C	RR10025S	
S612H3-916L	3-9/16"	5.16 (131)	3.39 (86)	2.32 (59)	6.69 (170)	C	RR10025S	

6-PT								
Part Number	Output Size	D1 in (mm)	D2 in (mm)	T in (mm)	L in (mm)	Type	Recommended Retaining Ring	
<b>DEEP (cont'd)</b>								
S612H3-34L	3-3/4"	5.39 (137)	3.74 (95)	2.4 (61)	7.09 (180)	C	RR10025S	
S612H3-78L	3-7/8"	5.67 (144)	3.74 (95)	2.56 (65)	7.09 (180)	C	RR10025S	
S612H3-1516L	3-15/16"	5.67 (144)	3.74 (95)	2.56 (65)	7.48 (190)	C	RR10025S	
S612H4L	4"	5.79 (147)	3.74 (95)	2.56 (65)	7.48 (190)	C	RR10025S	
S612H4-116L	4-1/16"	5.79 (147)	3.74 (95)	2.68 (68)	7.48 (190)	C	RR10025S	
S612H4-18L	4-1/8"	6.06 (154)	3.74 (95)	2.68 (68)	7.48 (190)	C	RR10025S	
S612H4-316L	4-3/16"	6.06 (154)	3.74 (95)	2.68 (68)	7.48 (190)	C	RR10025S	
S612H4-14L	4-1/4"	6.06 (154)	3.74 (95)	2.83 (72)	7.48 (190)	C	RR10025S	
S612H4-516L	4-5/16"	6.18 (157)	3.74 (95)	2.83 (72)	7.87 (200)	C	RR10025S	
S612H4-38L	4-3/8"	6.18 (157)	3.74 (95)	2.83 (72)	7.87 (200)	C	RR10025S	
S612H4-716L	4-7/16"	6.18 (157)	3.74 (95)	2.83 (72)	7.87 (200)	C	RR10025S	
S612H4-12L	4-1/2"	6.46 (164)	3.74 (95)	3.03 (77)	8.27 (210)	C	RR10025S	
S612H4-58L	4-5/8"	6.46 (164)	3.74 (95)	3.03 (77)	8.27 (210)	C	RR10025S	
S612H4-34L	4-3/4"	6.57 (167)	3.74 (95)	3.03 (77)	8.27 (210)	C	RR10025S	
S612M41L	41 mm	2.76 (70)	3.39 (86)	1.1 (28)	4.53 (115)	A	RR10025S	
S612M46L	46 mm	2.99 (76)	3.39 (86)	1.18 (30)	4.53 (115)	A	RR10025S	
S612M50L	50 mm	3.19 (81)	3.39 (86)	1.34 (34)	5.31 (135)	A	RR10025S	
S612M54L	54 mm	3.39 (86)	3.39 (86)	1.46 (37)	5.51 (140)	B	RR10025S	
S612M55L	55 mm	3.43 (87)	3.39 (86)	1.46 (37)	5.51 (140)	C	RR10025S	
S612M57L	57 mm	3.54 (90)	3.39 (86)	1.54 (39)	5.91 (150)	C	RR10025S	
S612M60L	60 mm	3.7 (94)	3.39 (86)	1.54 (39)	5.91 (150)	C	RR10025S	
S612M62L	62 mm	3.78 (96)	3.39 (86)	1.65 (42)	5.91 (150)	C	RR10025S	
S612M65L	65 mm	3.94 (100)	3.39 (86)	1.65 (42)	5.91 (150)	C	RR10025S	
S612M70L	70 mm	4.17 (106)	3.39 (86)	1.81 (46)	6.3 (160)	C	RR10025S	
S612M73L	73 mm	4.33 (110)	3.39 (86)	1.93 (49)	6.3 (160)	C	RR10025S	
S612M75L	75 mm	4.41 (112)	3.39 (86)	1.93 (49)	6.69 (170)	C	RR10025S	
S612M76L	76 mm	4.45 (113)	3.39 (86)	1.93 (49)	6.69 (170)	C	RR10025S	
S612M78L	78 mm	4.53 (115)	3.39 (86)	2.09 (53)	6.69 (170)	C	RR10025S	
S612M80L	80 mm	4.69 (119)	3.39 (86)	2.09 (53)	6.69 (170)	C	RR10025S	
S612M85L	85 mm	4.92 (125)	3.39 (86)	2.2 (56)	6.69 (170)	C	RR10025S	
S612M90L	90 mm	5.16 (131)	3.39 (86)	2.32 (59)	6.69 (170)	C	RR10025S	
S612M95L	95 mm	5.39 (137)	3.74 (95)	2.4 (61)	7.09 (180)	C	RR10025S	
S612M100L	100 mm	5.67 (144)	3.74 (95)	2.56 (65)	7.48 (190)	C	RR10025S	
S612M105L	105 mm	6.06 (154)	3.74 (95)	2.68 (68)	7.48 (190)	C	RR10025S	
S612M110L	110 mm	6.18 (157)	3.74 (95)	2.83 (72)	7.87 (200)	C	RR10025S	
S612M115L	115 mm	6.46 (164)	3.74 (95)	3.03 (77)	8.27 (210)	C	RR10025S	
S612M120L	120 mm	6.57 (167)	3.74 (95)	3.03 (77)	8.27 (210)	C	RR10025S	

Accessories

	Description	Output Size	Recommended Retaining Ring
<b>A12F8M</b>	1-1/2" female to 1" male adapter	1"	RR10025S
<b>A12F20M</b>	1-1/2" female to 2-1/2" male adapter	2-1/2"	RR10025S
<b>J12</b>	Universal joint	#5 Spline	RR10025S
<b>E125H</b>	5" Extension	1-1/2"	RR10025S
<b>E1210H</b>	10" Extension	1-1/2"	RR10025S
<b>E1212H</b>	12" Extension	1-1/2"	RR10025S
<b>E1220H</b>	20" Extension	1-1/2"	RR10025S



Universal Joint

2-1/2" Square Drive Impact Sockets

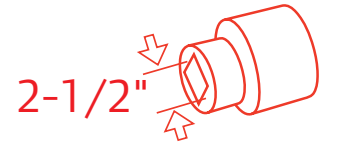

Individuals

6-PT	Part Number	Output Size	D1 in (mm)	D2 in (mm)	T in (mm)	L in (mm)	Type	Recommended Retaining Ring or O-Ring / Pin
STANDARD	S620H3	3"	4.72 (120)	5 (127)	1.77 (45)	5.51 (140)	A	RR10035S
	S620H3-18	3-1/8"	4.88 (124)	5 (127)	1.77 (45)	5.51 (140)	A	RR10035S
	S620H3-14	3-1/4"	5 (127)	5 (127)	1.77 (45)	5.51 (140)	B	RR10035S
	S620H3-38	3-3/8"	5.16 (131)	5 (127)	2.05 (52)	5.51 (140)	C	RR10035S
	S620H3-12	3-1/2"	5.31 (135)	5 (127)	2.05 (52)	5.51 (140)	C	RR10035S
	S620H3-58	3-5/8"	5.47 (139)	5 (127)	2.05 (52)	5.71 (145)	C	RR10035S
	S620H3-34	3-3/4"	5.63 (143)	5 (127)	2.05 (52)	5.71 (145)	C	RR10035S
	S620H3-78	3-7/8"	5.79 (147)	5 (127)	2.28 (58)	5.91 (150)	C	RR10035S
	S620H4	4"	5.94 (151)	5 (127)	2.28 (58)	5.91 (150)	C	RR10035S
	S620H4-18	4-1/8"	6.1 (155)	5 (127)	2.28 (58)	6.1 (155)	C	RR10035S
	S620H4-14	4-1/4"	6.26 (159)	5 (127)	2.36 (60)	6.3 (160)	C	RR10035S
	S620H4-38	4-3/8"	6.42 (163)	5 (127)	2.44 (62)	6.5 (165)	C	RR10035S
	S620H4-12	4-1/2"	6.57 (167)	5 (127)	2.44 (62)	6.5 (165)	C	RR10035S
	S620H4-58	4-5/8"	6.77 (172)	5 (127)	2.64 (67)	6.69 (170)	C	RR10035S
	S620H4-34	4-3/4"	6.93 (176)	5 (127)	2.64 (67)	6.69 (170)	C	RR10035S
	S620H4-78	4-7/8"	7.24 (184)	5 (127)	2.83 (72)	6.89 (175)	C	RR10035S
	S620H5	5"	7.24 (184)	5 (127)	2.83 (72)	6.89 (175)	C	RR10035S
	S620H5-18	5-1/8"	7.36 (187)	5.98 (152)	2.83 (72)	6.89 (175)	C	588-216 & 588-215
	S620H5-14	5-1/4"	7.64 (194)	5.98 (152)	2.83 (72)	6.89 (175)	C	588-216 & 588-215
	S620H5-38	5-3/8"	7.76 (197)	5.98 (152)	3.03 (77)	7.09 (180)	C	588-216 & 588-215
	S620H5-12	5-1/2"	8.03 (204)	5.98 (152)	3.03 (77)	7.09 (180)	C	588-216 & 588-215
	S620H5-58	5-5/8"	8.15 (207)	5.98 (152)	3.27 (83)	7.28 (185)	C	588-216 & 588-215
	S620H5-34	5-3/4"	8.43 (214)	5.98 (152)	3.27 (83)	7.28 (185)	C	588-216 & 588-215
	S620H5-78	5-7/8"	8.43 (214)	5.98 (152)	3.27 (83)	7.28 (185)	C	588-216 & 588-215
	S620H6	6"	8.54 (217)	5.98 (152)	3.27 (83)	7.28 (185)	C	588-216 & 588-215
	S620H6-18	6-1/8"	8.82 (224)	5.98 (152)	3.54 (90)	7.48 (190)	C	588-216 & 588-215
	S620H6-14	6-1/4"	8.94 (227)	5.98 (152)	3.54 (90)	7.48 (190)	C	588-216 & 588-215
	S620H6-38	6-3/8"	9.21 (234)	5.98 (152)	3.74 (95)	7.68 (195)	C	588-216 & 588-215
	S620H6-12	6-1/2"	9.21 (234)	5.98 (152)	3.74 (95)	7.68 (195)	C	588-216 & 588-215
	S620H6-58	6-5/8"	9.33 (237)	5.98 (152)	3.74 (95)	7.68 (195)	C	588-216 & 588-215
S620H6-34	6-3/4"	9.61 (244)	5.98 (152)	3.74 (95)	7.68 (195)	C	588-216 & 588-215	
S620H6-78	6-7/8"	9.72 (247)	5.98 (152)	3.94 (100)	7.87 (200)	C	588-216 & 588-215	
S620H7	7"	10 (254)	5.98 (152)	3.94 (100)	7.87 (200)	C	588-216 & 588-215	
S620H7-12	7-1/2"	10.39 (264)	5.98 (152)	4.13 (105)	8.27 (210)	C	588-216 & 588-215	
S620H7-58	7-5/8"	10.51 (267)	5.98 (152)	4.13 (105)	8.27 (210)	C	588-216 & 588-215	

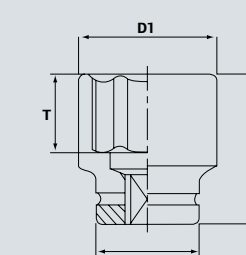
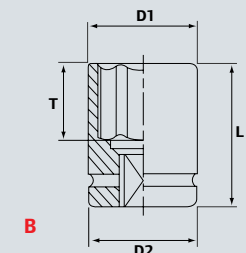
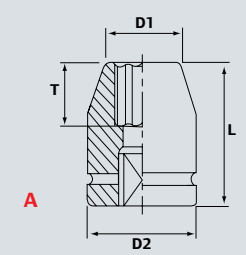

Impact Sockets

Impact Sockets



6-PT								
Part Number	Output Size	D1 in (mm)	D2 in (mm)	T in (mm)	L in (mm)	Type	Recommended Retaining Ring or O-Ring / Pin	
STANDARD (cont'd)								
S620H7-78	7-7/8"	10.79 (274)	5.98 (152)	4.33 (110)	8.66 (220)	C	588-216 & 588-215	
S620H8	8"	10.91 (277)	5.98 (152)	4.33 (110)	8.66 (220)	C	588-216 & 588-215	
S620M75	75 mm	4.65 (118)	5 (127)	1.65 (42)	5.51 (140)	A	RR10035S	
S620M76	76 mm	4.8 (122)	5 (127)	1.77 (45)	5.51 (140)	A	RR10035S	
S620M80	80 mm	4.88 (124)	5 (127)	1.77 (45)	5.51 (140)	B	RR10035S	
S620M85	85 mm	5.12 (130)	5 (127)	2.05 (52)	5.51 (140)	C	RR10035S	
S620M90	90 mm	5.35 (136)	5 (127)	2.05 (52)	5.71 (145)	C	RR10035S	
S620M95	95 mm	5.63 (143)	5 (127)	2.05 (52)	5.71 (145)	C	RR10035S	
S620M100	100 mm	5.87 (149)	5 (127)	2.28 (58)	5.91 (150)	C	RR10035S	
S620M105	105 mm	6.1 (155)	5 (127)	2.28 (58)	6.1 (155)	C	RR10035S	
S620M110	110 mm	6.34 (161)	5 (127)	2.36 (60)	6.3 (160)	C	RR10035S	
S620M115	115 mm	6.57 (167)	5 (127)	2.44 (62)	6.5 (165)	C	RR10035S	
S620M120	120 mm	6.93 (176)	5 (127)	2.64 (67)	6.69 (170)	C	RR10035S	
S620M125	125 mm	7.24 (184)	5 (127)	2.83 (72)	6.89 (175)	C	RR10035S	
S620M130	130 mm	7.36 (187)	5.98 (152)	2.83 (72)	6.89 (175)	C	588-216 & 588-215	
S620M135	135 mm	7.64 (194)	5.98 (152)	3.03 (77)	7.09 (180)	C	588-216 & 588-215	
S620M140	140 mm	8.03 (204)	5.98 (152)	3.03 (77)	7.09 (180)	C	588-216 & 588-215	
S620M145	145 mm	8.15 (207)	5.98 (152)	3.27 (83)	7.28 (185)	C	588-216 & 588-215	
S620M150	150 mm	8.43 (214)	5.98 (152)	3.27 (83)	7.28 (185)	C	588-216 & 588-215	
S620M155	155 mm	8.82 (224)	5.98 (152)	3.54 (90)	7.48 (190)	C	588-216 & 588-215	
S620M160	160 mm	8.94 (227)	5.98 (152)	3.54 (90)	7.48 (190)	C	588-216 & 588-215	
S620M165	165 mm	9.21 (234)	5.98 (152)	3.74 (95)	7.68 (195)	C	588-216 & 588-215	
S620M170	170 mm	9.61 (244)	5.98 (152)	3.74 (95)	7.68 (195)	C	588-216 & 588-215	
S620M175	175 mm	9.72 (247)	5.98 (152)	3.94 (100)	7.87 (200)	C	588-216 & 588-215	
S620M180	180 mm	10 (254)	5.98 (152)	3.94 (100)	7.87 (200)	C	588-216 & 588-215	
S620M185	185 mm	10.12 (257)	5.98 (152)	4.13 (105)	8.27 (210)	C	588-216 & 588-215	
S620M190	190 mm	10.39 (264)	5.98 (152)	4.13 (105)	8.27 (210)	C	588-216 & 588-215	
S620M200	200 mm	10.79 (274)	5.98 (152)	4.33 (110)	8.66 (220)	C	588-216 & 588-215	

## #5 Spline Square Drive Impact Sockets



### Individuals

6-PT								
Part Number	Output Size	D1 in (mm)	D2 in (mm)	T in (mm)	L in (mm)	Type		
STANDARD								
	S65SH1-116	1-1/16"	1.89 (48)	2.17 (55)	0.94 (24)	3.15 (80)	A	
	S65SH1-118	1-1/8"	1.89 (48)	2.17 (55)	0.94 (24)	3.15 (80)	A	
	S65SH1-114	1-1/4"	2.17 (55)	2.17 (55)	0.94 (24)	3.15 (80)	B	
	S65SM33	33 mm	2.17 (55)	2.17 (55)	0.94 (24)	3.15 (80)	B	
	S65SM35	35 mm	2.24 (57)	2.17 (55)	0.94 (24)	3.15 (80)	C	
	S65SM38	38 mm	2.36 (60)	2.17 (55)	0.94 (24)	3.15 (80)	C	
	S65SM41	41 mm	2.64 (67)	2.17 (55)	0.94 (24)	3.15 (80)	C	
	S65SH1-34	1-3/4"	2.87 (73)	2.56 (65)	1.5 (38)	3.15 (80)	C	
	S65SH1-12	1-1/2"	2.36 (60)	2.17 (55)	0.94 (24)	3.15 (80)	C	
	S65SH78	7/8"	1.73 (44)	2.17 (55)	0.94 (24)	3.15 (80)	A	
	S65SH1516	15/16"	1.73 (44)	2.17 (55)	0.94 (24)	3.15 (80)	A	
	S65SH1	1"	1.81 (46)	2.17 (55)	0.94 (24)	3.15 (80)	A	
	S65SH1-316	1-3/16"	2.01 (51)	2.17 (55)	0.94 (24)	3.15 (80)	A	
	4-PT							
	STANDARD							
	S45SM17	17 mm	1.73 (44)	2.17 (55)	0.94 (24)	3.15 (80)	A	
S45SM21	21 mm	1.73 (44)	2.17 (55)	0.94 (24)	3.15 (80)	A		
S45SH1316	13/16"	1.73 (44)	2.17 (55)	0.94 (24)	3.15 (80)	A		
S45SH1516	15/16"	1.73 (44)	2.17 (55)	0.94 (24)	3.15 (80)	A		

## Accessories

Description	Output Size	Recommended Retaining Ring
A20F12M 2-1/2" female to 1-1/2" male adapter	1-1/2"	R10035S
E205H 5" Extension	2-1/2"	R10035S
E2010H 10" Extension	2-1/2"	R10035S
E2020H 20" Extension	2-1/2"	R10035S



Extension

## Retaining Rings

	Part Number	Quantity	Internal in (mm)	Material
	RR10001	10	3/5" (15)	Plastic
	RR10002	10	2/3" (17)	Plastic
	RR10003	10	3/4" (19)	Plastic
	RR10004	10	4/5" (20)	Plastic
	RR10011	10	5/6" (20.8)	Plastic
	RR10005	10	6/7" (22)	Plastic
	RR10006	10	1" (24)	Plastic
	RR10008	10	1-1/7" (29)	Plastic
	RR10013	10	1-1/5" (30.5)	Plastic
	RR10005S	1	1-1/4" (32)	Plastic & Steel insert
	RR10009	10	1-2/7" (33)	Plastic
	RR10032S	1	1-3/7" (36.5)	Plastic & Steel insert
	RR10010	10	1-1/2" (37)	Plastic
	RR10034S	1	1-5/8" (41.5)	Plastic & Steel insert
	RR10008S	1	1-3/4" (44.5)	Plastic & Steel insert
	RR10010S	1	2" (49)	Plastic & Steel insert
	RR10015S	1	2-1/8" - 2-1/4" (54-57)	Plastic & Steel insert
	RR10017S	1	2-1/2" (63.5)	Plastic & Steel insert
	RR10019S	1	2-2/3" (67)	Plastic & Steel insert
	RR10020S	1	3" (76)	Plastic & Steel insert
RR10025S	1	3-2/5" (86)	Plastic & Steel insert	
RR10030S	1	3-7/8" (98.5)	Plastic & Steel insert	
RR10035S	1	4-3/8" (111)	Plastic & Steel insert	

## Industrial Grade Impact Socket Displays

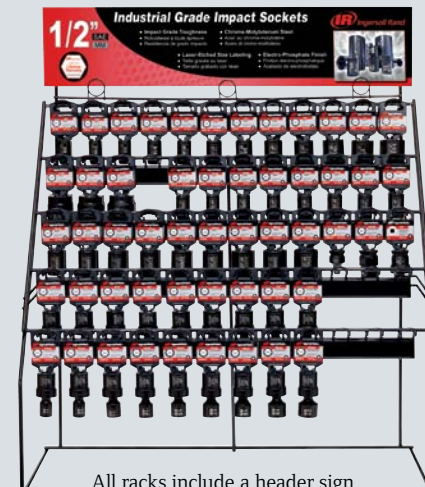
	Part Number	Description	Dimensions (H x W x D)	Weight (lb)
<p>Ingersoll Rand offers an extensive line of display racks to enhance your P.O.P. sales. Each display comes with an array of sockets and accessories for available drive sizes. Details of what is included with each display rack can be found in the Socket Display catalog (IRITS-1107-047) or at <a href="http://ingersollrandproducts.com/accessories">ingersollrandproducts.com/accessories</a>.</p>  <p>All racks include a header sign.</p> <p>Versatile displays mount on pegboard or can be used as a freestanding counter display as shown!</p>	SD-38S	3/8" Drive standard impact sockets	22" x 24" x 16"	23
	SD-38D	3/8" Drive deep impact sockets	22" x 24" x 16"	42
	SD-38C	3/8" Drive combo impact sockets	22" x 24" x 16"	32
	SD-12S	1/2" Drive standard impact sockets	22" x 24" x 16"	39
	SD-12D	1/2" Drive deep impact sockets	22" x 24" x 16"	66
	SD-12C	1/2" Drive combo impact sockets	22" x 24" x 16"	66
	SD-34	3/4" Drive standard & deep impact sockets	27.25" x 24.5" x 2"	75
	SD-1	1" Drive standard & deep impact sockets	27.25" x 24.5" x 2"	105



# Pneumatic Tool Steels & Accessories



## Pavement Breaker & Digger Steels

Choose from a complete line of tool steels for your pavement breakers, with products for many applications including concrete, asphalt, excavation, and general demolition.

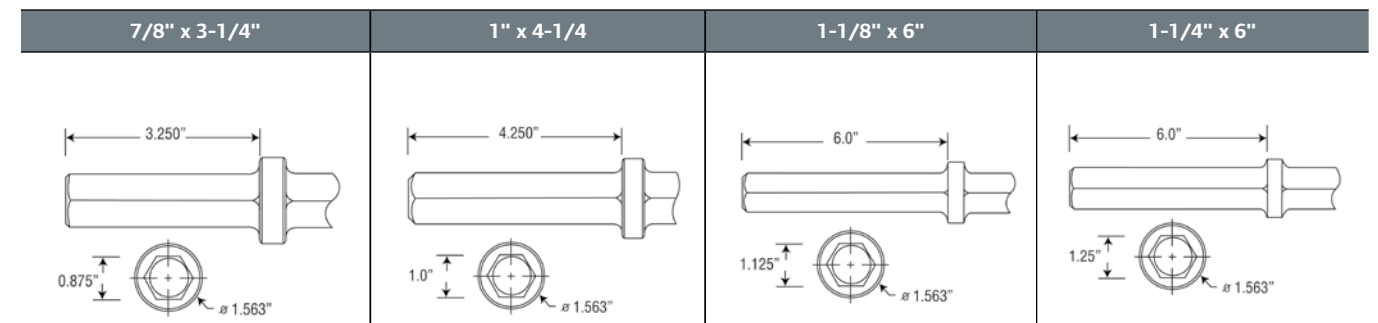

### Moil Point



General demolition

Hex Shank Size	7/8" x 3-1/4"		1" x 4-1/4"		1-1/8" x 6"		1-1/4" x 6"	
Length Under Collar	Part Number	Weight lb	Part Number	Weight lb	Part Number	Weight lb	Part Number	Weight lb
<b>MOIL POINT — STANDARD-DUTY</b>								
14"	50050269	3.25	50050368	4.5	50050475	6	50055680	7.5
18"	50050277	4	50050376	5.5	50055524	7.25	50055698	9
24"	50050285	5.25	50050392	6.75	50055540	9.5	50055714	11.25
36"	51305860	7.5	45512563	10	50055565	13.25	50055730	15.75
48"	45512621	9.75	45512571	13	50055573	17	50055748	20.5
60"	45512639	12	45512589	15.75	50055581	20.5	50055755	25
72"	45512647	14.25	45512597	18.75	50055599	24	50198993	29.5
84"	-	-	45512605	21.75	45512514	28	45512688	34
96"	-	-	45512613	24.5	45512522	31.75	45512696	38.75
120"	-	-	45512530	30.5	45512480	39.75	45512654	48.5
144"	-	-	45512548	36.75	45512498	47.5	45512662	58.25
168"	-	-	45512555	42.75	45512506	55.5	45512670	68
<b>MOIL POINT — SUPER-DUTY</b>								
11-1/4"	22041495	3.5	22041057	4	22041073	6.5	22041099	7.5
14-1/4"	22041602	3.75	22041065	5.25	22041081	6.75	22041107	8



1" Narrow Chisel



General demolition

Hex Shank Size	7/8" x 3-1/4"		1" x 4-1/4"		1-1/8" x 6"		1-1/4" x 6"	
Length Under Collar	Part Number	Weight lb	Part Number	Weight lb	Part Number	Weight lb	Part Number	Weight lb
<b>1" NARROW CHISELS — STANDARD-DUTY</b>								
14"	50199207	3.25	50197805	4.5	50197904	6	50196385	7.5
18"	50199215	4	50197821	5.5	50197912	7.25	50196401	9
24"	50199223	5.25	45510245	6.75	50197938	9.5	50196419	11.25
36"	45510682	7.5	45510252	10	51298107	13.25	51299477	15.75
48"	45510690	9.75	45510260	13	50197979	17	51299485	20.5
60"	45510708	12	45510278	15.75	50197987	20.5	51299048	25
72"	45510716	14.25	45510286	18.75	50197995	24	51299493	29.5
84"	-	-	45510294	21.75	45510385	28	45509965	34
96"	-	-	45510302	24.5	45510393	31.75	45509973	38.75
120"	-	-	45510211	30.5	45510401	39.75	45509932	48.5
144"	-	-	45510229	36.75	45510369	47.5	45509940	58
168"	-	-	45510237	42.75	45510377	55.5	45509957	67.75
<b>1" NARROW CHISELS — SUPER-DUTY</b>								
11-1/4"	22041503	3.5	22041115	4	22041131	6.5	22041156	7.5
14-1/4"	22041610	3.75	22041123	5.25	22041149	6.75	22041164	8

3" Chisel



Concrete demolition and asphalt cutting

Hex Shank Size	7/8" x 3-1/4"		1" x 4-1/4"		1-1/8" x 6"		1-1/4" x 6"	
Length Under Collar	Part Number	Weight lb	Part Number	Weight lb	Part Number	Weight lb	Part Number	Weight lb
<b>3" CHISELS</b>								
14"	50195288	3.25	50195320	4.5	50114883	6	50193879	7.5
18"	50195296	4	50195338	5.5	50193754	7.25	50193887	9
24"	45510542	5.5	50195353	6.75	50193747	9.75	50193903	12.25
36"	45510559	8	50195361	10	45510500	13.5	45510484	16.75
48"	45510567	10	50195379	12.75	45510518	17.25	50193937	21.25
60"	45510575	12.25	45510476	16.5	45510526	21	45510492	26
72"	45510583	14	51304574	19.25	45510534	24.75	50191790	30

1-1/2" Super Cut Chisel



Specially designed for breaking concrete

Hex Shank Size	7/8" x 3-1/4"		1" x 4-1/4"		1-1/8" x 6"		1-1/4" x 6"	
Length Under Collar	Part Number	Weight lb	Part Number	Weight lb	Part Number	Weight lb	Part Number	Weight lb
<b>1-1/2" SUPER CUT CHISEL</b>								
16"	-	-	22040463	4.5	22040471	8	22040489	9.25

3-3/4" Combo Cutter



Great for manhole reconstruction

Hex Shank Size	7/8" x 3-1/4"		1" x 4-1/4"		1-1/8" x 6"		1-1/4" x 6"	
Length Under Collar	Part Number	Weight lb	Part Number	Weight lb	Part Number	Weight lb	Part Number	Weight lb
<b>3-3/4" COMBO CUTTER</b>								
12"	-	-	-	-	22040612	8.5	22040620	9.5

5" Asphalt Cutter



Asphalt cutting and removal

Hex Shank Size	7/8" x 3-1/4"		1" x 4-1/4"		1-1/8" x 6"		1-1/4" x 6"	
Length Under Collar	Part Number	Weight lb	Part Number	Weight lb	Part Number	Weight lb	Part Number	Weight lb
<b>5" ASPHALT CUTTER</b>								
12"	22040935	6.75	50190404	7.25	50185982	8.5	50185990	9.25

5-1/2" Clay Spade



Trench digging and trimming

Hex Shank Size	7/8" x 3-1/4"		1" x 4-1/4"		1-1/8" x 6"		1-1/4" x 6"	
Length Under Collar	Part Number	Weight lb	Part Number	Weight lb	Part Number	Weight lb	Part Number	Weight lb
<b>5-1/2" CLAY SPADE</b>								
16"	50189596	7	50189554	7.25	50189562	8.5	50189570	11

3" Digging Chisel



Digging and deeper asphalt cutting

Hex Shank Size	7/8" x 3-1/4"		1" x 4-1/4"		1-1/8" x 6"		1-1/4" x 6"	
Length Under Collar	Part Number	Weight lb	Part Number	Weight lb	Part Number	Weight lb	Part Number	Weight lb
<b>3" DIGGING CHISEL</b>								
16"	22040968	7.5	22040976	8	22040984	10	50186014	11.5

Frost Wedge



Used for breaking frozen ground

Hex Shank Size	7/8" x 3-1/4"		1" x 4-1/4"		1-1/8" x 6"		1-1/4" x 6"	
Length Under Collar	Part Number	Weight lb	Part Number	Weight lb	Part Number	Weight lb	Part Number	Weight lb
<b>FROST WEDGE</b>								
16-1/2"	FW40810	7	FW40820	10	FW40830	13	FW40840	18

Bushing Tool



Concrete surface removal or roughing

Hex Shank Size	7/8" x 3-1/4"		1" x 4-1/4"		1-1/8" x 6"		1-1/4" x 6"	
Length Under Collar	Part Number	Weight lb	Part Number	Weight lb	Part Number	Weight lb	Part Number	Weight lb
<b>BUSHING TOOL</b>								
9"	BT41310	5	BT41320	6.5	BT41330	7	BT41340	7.25

Concrete Breaker



Breaking up concrete; driven into drilled hole

Hex Shank Size	7/8" x 3-1/4"		1" x 4-1/4"		1-1/8" x 6"		1-1/4" x 6"	
Length Under Collar	Part Number	Weight lb	Part Number	Weight lb	Part Number	Weight lb	Part Number	Weight lb
<b>CONCRETE BREAKER</b>								
14-1/2"	-	-	-	-	CB40960	11.25	CB40970	12.25

1" Pipe Driver



Driving steel pipe up to 1" O.D.

Hex Shank Size	7/8" x 3-1/4"		1" x 4-1/4"		1-1/8" x 6"		1-1/4" x 6"	
Length Under Collar	Part Number	Weight lb	Part Number	Weight lb	Part Number	Weight lb	Part Number	Weight lb
<b>1" PIPE DRIVER</b>								
11"	-	-	-	-	22040505	5	22040513	6.5

1-1/2" Pipe Driver



Driving steel pipe up to 1-1/2" O.D.

Hex Shank Size	7/8" x 3-1/4"		1" x 4-1/4"		1-1/8" x 6"		1-1/4" x 6"	
Length Under Collar	Part Number	Weight lb	Part Number	Weight lb	Part Number	Weight lb	Part Number	Weight lb
<b>1-1/2" PIPE DRIVER</b>								
11"	-	-	-	-	22040547	7	22040554	7.5

Ground Rod Driver



Driving steel rod up to 1" O.D.

Hex Shank Size	7/8" x 3-1/4"		1" x 4-1/4"		1-1/8" x 6"		1-1/4" x 6"	
Length Under Collar	Part Number	Weight lb	Part Number	Weight lb	Part Number	Weight lb	Part Number	Weight lb
<b>GROUND ROD DRIVER</b>								
9"	-	-	22040588	5.25	22040596	6.75	22040604	7.25

3-Piece Sign Post Driver



Includes shank, post block, and 3-1/2" driver

Hex Shank Size	7/8" x 3-1/4"		1" x 4-1/4"		1-1/8" x 6"		1-1/4" x 6"	
Length Under Collar	Part Number	Weight lb	Part Number	Weight lb	Part Number	Weight lb	Part Number	Weight lb
<b>3-PIECE SIGN POST DRIVER</b>								
7-3/4"	22040778	5	22040943	5.25	22041008	5.25	22041016	6

Detachable Shank



Used with tent stake drivers and tamping pads

Hex Shank Size	7/8" x 3-1/4"		1" x 4-1/4"		1-1/8" x 6"		1-1/4" x 6"	
Length Under Collar	Part Number	Weight lb	Part Number	Weight lb	Part Number	Weight lb	Part Number	Weight lb
<b>DETACHABLE SHANK</b>								
9"	22040927	4	50187830	4.5	50187848	5.25	50187855	6

2" Tent Stake Driver



Used with detachable shank

Hex Shank Size	7/8" x 3-1/4"		1" x 4-1/4"		1-1/8" x 6"		1-1/4" x 6"	
Length Under Collar	Part Number	Weight lb	Part Number	Weight lb	Part Number	Weight lb	Part Number	Weight lb
<b>2" TENT STAKE DRIVER</b>								
N/A	22040638	3.5	22040638	3.5	22040638	3.5	22040638	3.5

2-1/2" Tent Stake Driver



Used with detachable shank

Hex Shank Size	7/8" x 3-1/4"		1" x 4-1/4"		1-1/8" x 6"		1-1/4" x 6"	
Length Under Collar	Part Number	Weight lb	Part Number	Weight lb	Part Number	Weight lb	Part Number	Weight lb
<b>2-1/2" TENT STAKE DRIVER</b>								
N/A	22040646	4	22040646	4	22040646	4	22040646	4

6" Tamping Pad Square



Tamping and backfilling; used with detachable shank

Hex Shank Size	7/8" x 3-1/4"		1" x 4-1/4"		1-1/8" x 6"		1-1/4" x 6"	
Length Under Collar	Part Number	Weight lb	Part Number	Weight lb	Part Number	Weight lb	Part Number	Weight lb
<b>6" TAMPING PAD SQUARE</b>								
N/A	51305894	10.5	51305894	10.5	51305894	10.5	51305894	10.5

8" Tamping Pad Square



Tamping and backfilling; used with detachable shank

Hex Shank Size	7/8" x 3-1/4"		1" x 4-1/4"		1-1/8" x 6"		1-1/4" x 6"	
Length Under Collar	Part Number	Weight lb	Part Number	Weight lb	Part Number	Weight lb	Part Number	Weight lb
<b>8" TAMPING PAD SQUARE</b>								
N/A	50187897	14.5	50187897	14.5	50187897	14.5	50187897	14.5

Pneumatic Tool Steels

Pneumatic Tool Steels

Plain-face

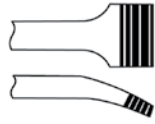

Hex Shank Size 1" x 4-1/4"					
Part Number	Dimensions in			Weight lb	Description
	A	B	C		
<b>PLAIN-FACE</b>					
45512720	24"	3"	3/8"	5.25	For spot-tamping and low lifts
45512738	24"	3"	5/8"	6.5	For rock ballast of 29 mesh or larger
45512746	24"	3"	7/8"	8	For small rock ballast, gravel, and slag
45512712	24"	3"	3/4"	7.25	For dirt, cinder, gravel, sand, or chat ballast
45512704	24"	3"	1-1/8"	8	For dirt, cinder, gravel, sand, or chat ballast

Tooth-face

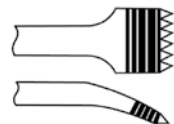

Hex Shank Size 1" x 4-1/4"					
Part Number	Dimensions in			Weight lb	Description
	A	B	C		
<b>TOOTH-FACE</b>					
45513231	24"	3"	5/8"	7.5	For stone ballast

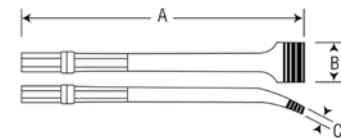

## Jackhammer & Rockdrill Rods & Bits

Our carbide-tipped drill steels are available in diameters from 5/8" to 1-5/8" to meet all of your drilling needs. Our complete range of shank sizes lets you use Ingersoll Rand drill steels with virtually any jackhammer or rockdrill.

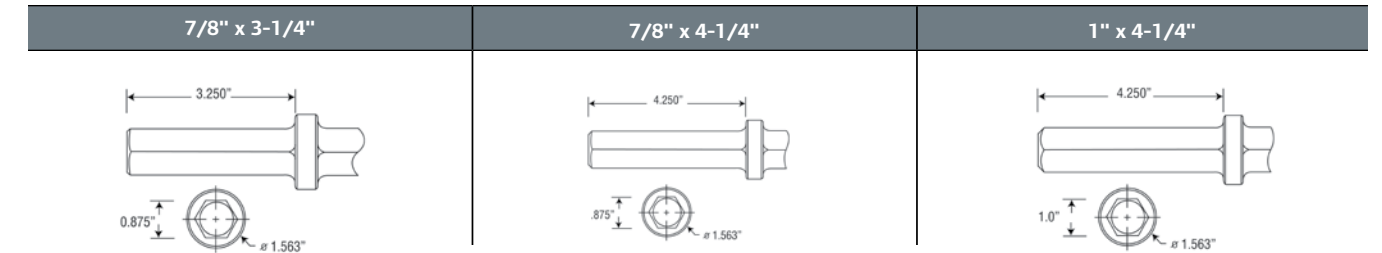

### Jackhammer Rods



Hexagon shank whirlibits carbide-tipped drill steels

Hex Shank Size		7/8" x 3-1/4"		7/8" x 4-1/4"		1" x 4-1/4"	
Diameter	Length Under Collar	Part Number	Weight lb	Part Number	Weight lb	Part Number	Weight lb
<b>HEXAGON SHANK WHIRLIBITS CARBIDE-TIPPED DRILL STEELS</b>							
5/8"	6"	9"	WB5869	1.5	WBA5869	1.75	-
5/8"	9"	12"	WB58912	1.75	WBA58912	2	-
5/8"	15"	18"	WB581518	2	WBA581518	2.25	-
5/8"	21"	24"	WB582124	2.5	WBA582124	2.75	-
5/8"	27"	30"	WB582730	3	WBA582730	3.25	-
3/4"	6"	9"	WB3469	1.75	WBA3469	2	-
3/4"	9"	12"	WB34912	2	WBA34912	2.25	WBC34912
3/4"	15"	18"	WB341518	2.5	WBA341518	2.75	WBC341518
3/4"	21"	24"	WB342124	3	WBA342124	3.25	WBC342124
3/4"	27"	30"	WB342730	3.5	WBA342730	3.75	WBC342730
3/4"	33"	36"	WB343336	3.75	WBA343336	4	-
3/4"	45"	48"	WB344548	4.25	WBA344548	4.5	-
7/8"	6"	9"	WB7869	2	WBA7869	2.25	-
7/8"	9"	12"	WB78912	2.5	WBA78912	2.75	WBC78912
7/8"	15"	18"	WB781518	3	WBA781518	3.25	WBC781518
7/8"	21"	24"	WB782124	3.75	WBA782124	4	WBC782124
7/8"	27"	30"	WB782730	4.5	WBA782730	4.75	WBC782730
7/8"	33"	36"	WB783336	5	WBA783336	5.25	WBC783336
7/8"	45"	48"	WB784548	6.25	WBA784548	6.5	-

Pneumatic Tool Steels

Pneumatic Tool Steels



Jackhammer Rods



Hexagon Shank Whirlbits  
Carbide-tipped Drill Steel

Hex Shank Size			7/8" x 3-1/4"		7/8" x 4-1/4"		1" x 4-1/4"	
Diameter	Depth	Length Under Collar	Part Number	Weight lb	Part Number	Weight lb	Part Number	Weight lb
<b>HEXAGON SHANK WHIRLIBITS CARBIDE-TIPPED DRILL STEELS</b>								
1"	9"	12"	WB1912	2.75	WBA1912	3	WBC1912	3
1"	15"	18"	WB11518	3.5	WBA11518	3.75	WBC11518	4
1"	21"	24"	WB12124	4.25	WBA12124	4.5	WBC12124	5
1"	27"	30"	WB12730	5.25	WBA12730	5.5	WBC12730	5.75
1"	33"	36"	WB13336	6	WBA13336	6.25	-	-
1"	45"	48"	WB14548	7.5	WBA14548	7.75	-	-
1-1/8"	9"	12"	WB118912	3	WBA118912	3.25	WBC118912	3.75
1-1/8"	15"	18"	WB1181518	4	WBA1181518	4.25	WBC1181518	4.5
1-1/8"	21"	24"	WB1182124	5	WBA1182124	5.25	WBC1182124	5.5
1-1/8"	27"	30"	WB1182730	6	WBA1182730	6.25	WBC1182730	6.75
1-1/8"	33"	36"	WB1183336	6.75	WBA1183336	7	WBC1183336	7.75
1-1/8"	45"	48"	WB1184548	8.75	WBA1184548	9	-	-
1-1/4"	9"	12"	WB114912	3	WBA114912	3.25	WBC114912	4.25
1-1/4"	15"	18"	WB1141518	4	WBA1141518	4.25	WBC1141518	5.5
1-1/4"	21"	24"	WB1142124	5	WBA1142124	5.25	WBC1142124	6.75
1-1/4"	27"	30"	WB1142730	6	WBA1142730	6.25	WBC1142730	8
1-1/4"	33"	36"	WB1143336	7	WBA1143336	7.25	-	-
1-1/4"	45"	48"	WB1144548	8.75	WBA1144548	9	WBC1144548	11.5
1-3/8"	9"	12"	WB138912	3.25	WBA138912	3.5	WBC138912	4.25
1-3/8"	15"	18"	WB1381518	4	WBA1381518	4.25	WBC1381518	5.5
1-3/8"	21"	24"	WB1382124	5.25	WBA1382124	5.5	WBC1382124	6.5
1-3/8"	27"	30"	WB1382730	6.25	WBA1382730	6.5	WBC1382730	8
1-3/8"	45"	48"	WB1384548	7.25	WBA1384548	9.25	-	-
1-1/2"	9"	12"	WB112912	3.25	WBA112912	3.5	WBC112912	4
1-1/2"	15"	18"	WB1121518	4.25	WBA1121518	4.5	WBC1121518	5.5
1-1/2"	21"	24"	WB1122124	5.25	WBA1122124	5.5	WBC1122124	6.75
1-1/2"	27"	30"	WB1122730	6.25	WBA1122730	6.5	WBC1122730	8
1-1/2"	45"	48"	WB1124548	9	-	-	-	-
1-5/8"	15"	18"	WB1581518	4	WBA1581518	4.25	-	-
1-5/8"	21"	24"	WB11582124	5.5	WBA11582124	5.75	WBC1582124	7

Jackhammer Rods



"H" thread rod

Hex Shank Size		7/8" x 3-1/4"		7/8" x 4-1/4"		1" x 4-1/4"	
Length Under Collar	Part Number	Weight lb	Part Number	Weight lb	Part Number	Weight lb	
<b>"H" THREAD RODS</b>							
12"	45509585	3	51242006	3.25	50713023	4	
18"	50283266	4	51242014	4.25	50713031	5	
24"	50283506	5	51233690	5.25	50354596	7	
30"	51305639	6	51242030	6.25	51305704	9	
36"	50712728	7	51234052	7.25	50713049	10	
48"	50283555	9	51234060	9.25	50283183	12	
60"	50712736	11	51242063	12	50713056	15	
72"	50712744	14	50712975	13.25	50283696	18	
96"	50712751	18	-	-	50283241	23	
120"	45509593	22	-	-	50712132	28	
144"	-	-	-	-	50712140	33.5	

Jackhammer Bits



"H" thread bit

Bit Size	Single-use Steel Bits		Multi-use Carbide Bits	
	Part Number	Weight lb	Part Number	Weight lb
<b>"H" THREAD BITS</b>				
1-3/8"	51248359	0.44	51307155	0.5
1-1/2"	51248367	0.46	51248300	0.6
1-5/8"	51248375	0.56	51248318	0.65
1-3/4"	51248383	0.6	51248326	0.8
1-7/8"	51248391	0.82	51248334	0.9
2"	51248409	0.88	51248342	1.1
2-1/4"	-	-	51356723	1.2
2-1/2"	-	-	51293017	1.3

## Rivet Buster Steels & Accessories

Our jumbo shank rivet buster steels and attachments are ideal for general demolition and steel demolition applications.

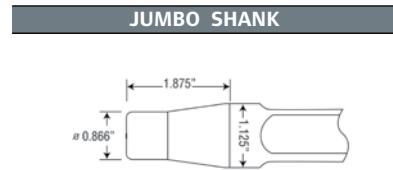

### Jumbo Shank Rivet Buster Steels

Length	Part Number	Weight lb
<b>MOIL POINTS</b>		
9"	9001-297-9	2
12"	9001-297-12	2.5
18"	9001-297-18	3.75
24"	9001-297-24	5.5
36"	9001-297-36	8
<b>FLAT CHISELS</b>		
9"	9001-276-9-1/2	2
12"	9001-276-12	2.5
18"	9001-276-18	3.75
24"	9001-276-24	5.5
36"	9001-276-36	8
<b>SIDE-CUT CHISELS</b>		
9"	9001-277-9-1/2	2
12"	9001-277-12	2.5
18"	9001-277-18	3.75
24"	9001-277-24	5.5
36"	9001-277-36	8
<b>RIPPERS</b>		
9"	9001-295-9-1/2	2
12"	9001-295-12	2.5

#### Moil Points



General demolition

#### Flat Chisels



General demolition

#### Side-cut Chisels



Steel, rivet cutting

#### Rippers



Splitting steel

#### Backout Punches



Removing bolts and rivets

#### Retainers



89938443



9001-200

#### Upper Sleeve



9001-220

#### Lower Sleeve



9001-201

#### Bumper



9001-203

#### Lock Clip



9RB-207

#### Spring Lock



89938450

#### Key



9001-208

#### Pin



FMD2-667

## Backout Punches

Length	Rivet Diameter	Part Number	Weight lb
<b>BACKOUT PUNCHES</b>			
9-1/2"	3/8"	9001-278	2
9-1/2"	1/2"	9001-279	2
9-1/2"	5/8"	9001-280	2
9-1/2"	3/4"	9001-281	2.25
9-1/2"	7/8"	9001-282	2.25
9-1/2"	1"	9001-283	2.25

## Rivet Buster Accessories

Barrel Threaded (9001, 11001) Part Number	Barrel Grooved (8001A, 9001A, 11001A) Part Number
<b>RETAINERS</b>	
-	89938443
9001-200	-

Barrel Threaded (9001, 11001) Part Number	Barrel Grooved (8001A, 9001A, 11001A) Part Number
<b>UPPER SLEEVE</b>	
9001-220	9001-220
<b>LOWER SLEEVE</b>	
9001-201	9001-201

Barrel Threaded (9001, 11001) Part Number	Barrel Grooved (8001A, 9001A, 11001A) Part Number
<b>BUMPER</b>	
9001-203	9001-203

Barrel Threaded (9001, 11001) Part Number	Barrel Grooved (8001A, 9001A, 11001A) Part Number
<b>LOCK CLIP</b>	
9RB-207	-
<b>SPRING LOCK</b>	
-	89938450

Barrel Threaded (9001, 11001) Part Number	Barrel Grooved (8001A, 9001A, 11001A) Part Number
<b>KEY</b>	
9001-208	-
<b>PIN</b>	
FMD2-667	-

## Chipping Hammer Steels & Accessories

Suitable for a wide range of applications, our chipping hammer steels are available with round or hex shanks and oval or round collars.



ROUND SHANK OVAL COLLAR	HEX SHANK OVAL COLLAR	ROUND SHANK ROUND COLLAR	HEX SHANK ROUND COLLAR

### Chipping Hammer Steels

Length	Part Number	Part Number	Part Number	Part Number	Weight lb
<b>BLANKS</b>					
12"	HH1-215-12	HH1-214-12	H3R-215-12	H3R-214-12	1.75
18"	HH1-215-18	HH1-214-18	H3R-215-18	H3R-214-18	2.75
24"	HH1-215-24	HH1-214-24	H3R-215-24	H3R-214-24	3.5
36"	HH1-215-36	HH1-214-36	H3R-215-36	H3R-214-36	5.5

#### Blanks



For making customized points

#### 1" Flat Chisels



General demolition

Length	Part Number	Part Number	Part Number	Part Number	Weight lb
<b>1" FLAT CHISELS</b>					
9"	HH1-215F-9	HH1-214F-9	H3R-215F-9	H3R-214F-9	1.25
12"	HH1-215F-12	HH1-214F-12	H3R-215F-12	H3R-214F-12	1.75
18"	HH1-215F-18	HH1-214F-18	H3R-215F-18	H3R-214F-18	2.5
24"	HH1-215F-24	HH1-214F-24	H3R-215F-24	H3R-214F-24	3
36"	HH1-215F-36	HH1-214F-36	H3R-215F-36	H3R-214F-36	5.25
48"	HH1-215F-48	HH1-214F-48	H3R-215F-48	H3R-214F-48	6
60"	HH1-215F-60	HH1-214F-60	H3R-215F-60	H3R-214F-60	9
72"	HH1-215F-72	HH1-214F-72	H3R-215F-72	H3R-214F-72	9.25
84"	HH1-215F-84	HH1-214F-84	H3R-215F-84	H3R-214F-84	13.25
96"	HH1-215F-96	HH1-214F-96	H3R-215F-96	H3R-214F-96	15.25

#### Moil Points



General demolition

#### 1-1/2" Scaling Chisels



General demolition

#### 2" Scaling Chisels



General demolition

#### 3" Scaling Chisels



General demolition

#### Bushing Tools



Concrete surface removal or roughing

Length	Part Number	Part Number	Part Number	Part Number	Weight lb
<b>MOIL POINTS</b>					
9"	HH1-215M-9	HH1-214M-9	H3R-215M-9	H3R-214M-9	1.25
12"	HH1-215M-12	HH1-214M-12	H3R-215M-12	H3R-214M-12	1.75
18"	HH1-215M-18	HH1-214M-18	H3R-215M-18	H3R-214M-18	2.5
24"	HH1-215M-24	HH1-214M-24	H3R-215M-24	H3R-214M-24	3
36"	HH1-215M-36	HH1-214M-36	H3R-215M-36	H3R-214M-36	5.25

Length	Part Number	Part Number	Part Number	Part Number	Weight lb
<b>1-1/2" SCALING CHISELS</b>					
9"	HH1-215B-9	HH1-214B-9	H3R-215B-9	H3R-214B-9	1.25
12"	HH1-215B-12	HH1-214B-12	H3R-215B-12	H3R-214B-12	1.75
18"	HH1-215B-18	HH1-214B-18	H3R-215B-18	H3R-214B-18	2.5

Length	Part Number	Part Number	Part Number	Part Number	Weight lb
<b>2" SCALING CHISELS</b>					
9"	HH1-323-9	HH1-324-9	H3R-423-9	H3R-424-9	1.25
12"	HH1-323-12	HH1-324-12	H3R-423-12	H3R-424-12	2
18"	HH1-323-18	HH1-324-18	H3R-423-18	H3R-424-18	2.5
24"	HH1-323-24	HH1-324-24	H3R-423-24	H3R-424-24	3.5
36"	HH1-323-36	HH1-324-36	H3R-423-36	H3R-424-36	5.25
48"	HH1-323-48	HH1-324-48	H3R-423-48	H3R-424-48	7
60"	HH1-323-60	HH1-324-60	H3R-423-60	H3R-424-60	9.25
72"	HH1-323-72	HH1-324-72	H3R-423-72	H3R-424-72	11
84"	HH1-323-84	HH1-324-84	H3R-423-84	H3R-424-84	12.5
96"	HH1-323-96	HH1-324-96	H3R-423-96	H3R-424-96	14.5

Length	Part Number	Part Number	Part Number	Part Number	Weight lb
<b>3" SCALING CHISEL</b>					
12"	HH1-215S-12	HH1-214S-12	H3R-215S-12	H3R-214S-12	2

Length	Part Number	Part Number	Part Number	Part Number	Weight lb
<b>BUSHING TOOL</b>					
9"	HH1-215T-9	HH1-214T-9	H3R-215T-9	H3R-214T-9	2.5



**Tooth**



Tamping aggregate material

	Round Shank Oval Collar	Hex Shank Oval Collar	Round Shank Round Collar	Hex Shank Round Collar	
<b>Length</b>	<b>Part Number</b>	<b>Part Number</b>	<b>Part Number</b>	<b>Part Number</b>	<b>Weight lb</b>
<b>TOOTH</b>					
12"	HH1-321-12	HH1-322-12	H3R-421-12	H3R-422-12	1.75

**Ripper**



Splitting steel

	Round Shank Oval Collar	Hex Shank Oval Collar	Round Shank Round Collar	Hex Shank Round Collar	
<b>Length</b>	<b>Part Number</b>	<b>Part Number</b>	<b>Part Number</b>	<b>Part Number</b>	<b>Weight lb</b>
<b>RIPPER</b>					
12"	HH1-215R-12	HH1-214R-12	H3R-215R-12	H3R-214R-12	1.75

**Round Nose**



Pointed for piercing holes

	Round Shank Oval Collar	Hex Shank Oval Collar	Round Shank Round Collar	Hex Shank Round Collar	
<b>Length</b>	<b>Part Number</b>	<b>Part Number</b>	<b>Part Number</b>	<b>Part Number</b>	<b>Weight lb</b>
<b>ROUND NOSE</b>					
12"	HH1-215N-12	HH1-214N-12	H3R-215N-12	H3R-214N-12	1.5

**Straight Fuller**



Used on pipe and metal

	Round Shank Oval Collar	Hex Shank Oval Collar	Round Shank Round Collar	Hex Shank Round Collar	
<b>Length</b>	<b>Part Number</b>	<b>Part Number</b>	<b>Part Number</b>	<b>Part Number</b>	<b>Weight lb</b>
<b>STRAIGHT FULLER</b>					
12"	HH1-215J-12	HH1-214J-12	H3R-215J-12	H3R-214J-12	1.5

**Gouge**



Cupped end for gouging wood and concrete

	Round Shank Oval Collar	Hex Shank Oval Collar	Round Shank Round Collar	Hex Shank Round Collar	
<b>Length</b>	<b>Part Number</b>	<b>Part Number</b>	<b>Part Number</b>	<b>Part Number</b>	<b>Weight lb</b>
<b>GOUGE</b>					
12"	HH1-215G-12	HH1-214G-12	H3R-215G-12	H3R-214G-12	1.5

**Caulking**

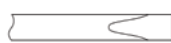

Caulk removal

	Round Shank Oval Collar	Hex Shank Oval Collar	Round Shank Round Collar	Hex Shank Round Collar	
<b>Length</b>	<b>Part Number</b>	<b>Part Number</b>	<b>Part Number</b>	<b>Part Number</b>	<b>Weight lb</b>
<b>CAULKING</b>					
12"	HH1-215E-12	HH1-214E-12	H3R-215E-12	H3R-214E-12	1.75

**Diamond Point**

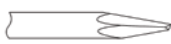

General demolition

	Round Shank Oval Collar	Hex Shank Oval Collar	Round Shank Round Collar	Hex Shank Round Collar	
<b>Length</b>	<b>Part Number</b>	<b>Part Number</b>	<b>Part Number</b>	<b>Part Number</b>	<b>Weight lb</b>
<b>DIAMOND POINT</b>					
12"	HH1-215D-12	HH1-214D-12	H3R-215D-12	H3R-214D-12	1.75

**Cape Chisel**



General demolition

	Round Shank Oval Collar	Hex Shank Oval Collar	Round Shank Round Collar	Hex Shank Round Collar	
<b>Length</b>	<b>Part Number</b>	<b>Part Number</b>	<b>Part Number</b>	<b>Part Number</b>	<b>Weight lb</b>
<b>CAPE CHISEL</b>					
12"	HH1-215C-12	HH1-214C-12	H3R-215C-12	H3R-214C-12	1.75

**Paper Box Stripping Chisel**

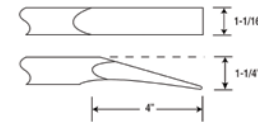

**Paper Box Stripping Chisel**

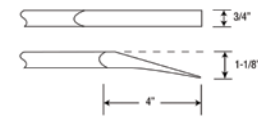

**Paper Box Stripping Chisel**

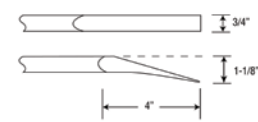

**Paper Box Stripping Chisel**

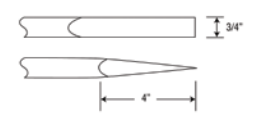

**Paper Box Stripping Chisel**

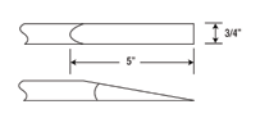

**Upper Buffer Washer**



**Lower Buffer Washer**



**Lower Buffer Washer Ring**



**Rubber Bumper**



**Lock Clip**



**Paper Box Stripping Chisels**

Round Shank Round Collar			
Length	Part Number	Dimensions	Weight lb
<b>PAPER BOX STRIPPING CHISEL</b>			
22"	HHW1-S215-1	1-1/16" x 1-1/4" x 4"	4

Round Shank Round Collar			
Length	Part Number	Dimensions	Weight lb
<b>PAPER BOX STRIPPING CHISEL</b>			
16-1/4"	HHW1-S215-2	3/4" x 1-1/8" x 4"	4

Round Shank Round Collar			
Length	Part Number	Dimensions	Weight lb
<b>PAPER BOX STRIPPING CHISEL</b>			
22"	HHW1-S215-3	3/4" x 1-1/8" x 4"	2.5

Round Shank Round Collar			
Length	Part Number	Dimensions	Weight lb
<b>PAPER BOX STRIPPING CHISEL</b>			
22"	HHW1-S215-4	3/4" x 4"	2.5

Round Shank Round Collar			
Length	Part Number	Dimensions	Weight lb
<b>PAPER BOX STRIPPING CHISEL</b>			
22"	HHW1-S215-5	3/4" x 5"	2

**Chipping Hammer Accessories**

Description	Part Number
<b>BUFFER WASHERS</b>	
Upper buffer washer (2 pieces)	H3R-31
Lower buffer washer (2 pieces)	HHW1-213

Description	Part Number
<b>LOWER BUFFER WASHER RING</b>	
Lower buffer washer ring	R000A2-103

Description	Part Number
<b>RUBBER BUMPER</b>	
Rubber bumper	H3R-203

Description	Part Number
<b>LOCK CLIP</b>	
Lock clip	24SR-207

Pneumatic Tool Steels

Pneumatic Tool Steels

### Chipping Hammer Retainers

Standard Retainer (grooved)



Barrel Area Type	K, A, D Series	Part Number	W Series
<b>STANDARD RETAINER (STANDARD ON ALL CHIPPERS ENDING IN "SA")</b>			
Grooved		HH1-1190	-

Quick-Change #1 (grooved)



Quick-Change #2 (grooved)



Barrel Area Type	K, A, D Series	Part Number	W Series
<b>QUICK-CHANGE #1</b>			
Grooved		HH1-1191	-
<b>QUICK-CHANGE #2</b>			
Grooved		HH1-3400-3	-

Lock Spring (grooved)



Barrel Area Type	K, A, D Series	Part Number	W Series
<b>LOCK SPRING (USED WITH ALL GROOVED RETAINERS LISTED ABOVE)</b>			
Grooved		HH1-1194	-

Rubber Buffered (threaded)



Barrel Area Type	K, A, D Series	Part Number	W Series
<b>RUBBER BUFFERED (STANDARD ON ALL W SERIES CHIPPERS)</b>			
Threaded	-		HHW1-A300

Economy Type (threaded)



Barrel Area Type	K, A, D Series	Part Number	W Series
<b>ECONOMY TYPE</b>			
Threaded	-		HHW2-200

Quick-Change (threaded)



Barrel Area Type	K, A, D Series	Part Number	W Series
<b>QUICK-CHANGE</b>			
Threaded	-		HHW1-3450

### Pneumatic Hammer Chisels

Tested to withstand the harshest environments, Ingersoll Rand is proud to offer the following pneumatic hammer accessories. All chisels are built from high-quality steel for the utmost in quality, strength, and durability.



1/2" Flat Chisel

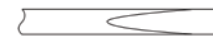

#### 0.401 Shank Chisels

Hex Shank Size 7"		9"		12"		18"	
Part Number	Weight lb	Part Number	Weight lb	Part Number	Weight lb	Part Number	Weight lb
<b>1/2" FLAT CHISEL</b>							
401FC127	0.5	401FC129	0.75	401FC1212	1	401FC1218	1.25

1/2" Offset Flat Chisel



Hex Shank Size 7"		9"		12"		18"	
Part Number	Weight lb	Part Number	Weight lb	Part Number	Weight lb	Part Number	Weight lb
<b>1/2" OFFSET FLAT CHISEL</b>							
401OFC127	0.5	401OFC129	0.75	401OFC1212	1	401OFC1218	1.25

1/2" Sidecut Chisel



Hex Shank Size 7"		9"		12"		18"	
Part Number	Weight lb	Part Number	Weight lb	Part Number	Weight lb	Part Number	Weight lb
<b>1/2" SIDECUT CHISEL</b>							
401SC127	0.75	401SC129	0.75	401SC1212	1	401SC1218	1.25

Offset Sidecut Chisel



Hex Shank Size 7"		9"		12"		18"	
Part Number	Weight lb	Part Number	Weight lb	Part Number	Weight lb	Part Number	Weight lb
<b>OFFSET SIDECUT CHISEL</b>							
401OSC127	0.75	-	-	-	-	-	-

1-1/4" Wide Flat Blade



Hex Shank Size 7"		9"		12"		18"	
Part Number	Weight lb	Part Number	Weight lb	Part Number	Weight lb	Part Number	Weight lb
<b>1-1/4" WIDE FLAT BLADE</b>							
401WBC1147	0.5	401WBC1149	0.75	401WBC11412	1	401WBC11418	1.25

Pneumatic Tool Steels

Pneumatic Tool Steels

Bull or Moil Point



0.401 Shank Chisels

Hex Shank Size 7"		9"		12"		18"	
Part Number	Weight lb	Part Number	Weight lb	Part Number	Weight lb	Part Number	Weight lb
<b>BULL OR MOIL</b>							
401MP7	0.5	401MP9	0.75	401MP12	1	401MP18	1.25

3/4" Flat Chisel



Hex Shank Size 7"		9"		12"		18"	
Part Number	Weight lb	Part Number	Weight lb	Part Number	Weight lb	Part Number	Weight lb
<b>3/4" FLAT CHISEL</b>							
401FC347	0.5	401FC349	0.75	401FC3412	1	401FC3418	1.5

Straight Blank

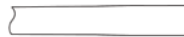

Hex Shank Size 7"		9"		12"		18"	
Part Number	Weight lb	Part Number	Weight lb	Part Number	Weight lb	Part Number	Weight lb
<b>STRAIGHT BLANK</b>							
401B07	0.5	401B09	0.75	401B12	1	401B18	1.25

Chisel Set

9500/9501



5-piece high-quality chisel set made of heat-treated alloy

- Tapered punch
- Flat chisel
- Panel cutter
- Sheet metal cutter
- Spot weld breaker

4-piece high-quality chisel set made of heat-treated alloy

- Tapered punch
- Panel cutter
- Flat chisel
- Spot weld breaker

Accessories

Quick Change Retainer

9512



Manufacturer	Fits Models
Ingersoll Rand	115, 116, 117, 121, 132
Chicago Pneumatic	All 0.401 shank hammers except CP7 16
Cleco	E3, E4, E15, E16
Dayton	All

- Quick-change hammer coupler
- Holds 0.401 shank chisels firmly in place; install by pulling back collar

Spring Retainer

9505



- 2 hammer-spring retainers
- Designed to guard against accidental shank release

Backfill Tamper & Sand Rammer Butts

Our line of tamper butts can meet all of your compaction needs. These products complement the Ingersoll Rand line of backfill tamper and sand rammer tools, and can be used with other manufacturers' tools as well.



Steel Butts



Part Number	Diameter	Fits Rods	Fits IR Tool
<b>STEEL BUTT</b>			
34SR-383	3"	7/8" tapered	341A2M



Part Number	Diameter	Fits Rods	Fits IR Tool
<b>STEEL BUTTS</b>			
12SR-83	2-1/2"	1/2" tapered	130A1M
22SR-83-3x3/4	3"	5/8" tapered	241A1M



Moon Steel Butt

Part Number	Diameter	Fits Rods	Fits IR Tool
<b>MOON STEEL BUTT</b>			
44SR-HM183-5	5-1/4"	1" tapered threaded	441A2



Malleable Butts

Part Number	Diameter	Fits Rods	Fits IR Tool
<b>MALLEABLE BUTTS</b>			
44SR-M183-5-3/4	5-3/4"	1" tapered threaded	441A2
34SR-M183-5-3/4	5-3/4"	7/8" tapered	341A2M

Rubber Topping-off Butts



Part Number	Diameter	Fits Rods	Fits IR Tool
<b>RUBBER TOPPING-OFF BUTTS</b>			
14SR-83R-4	3-29/32"	1/2" tapered	130A1M
24SR-83R-5	5"	5/8" tapered	241A1M

Rubber-tipped Butts



Part Number	Diameter	Fits Rods	Fits IR Tool
<b>RUBBER-TIPPED BUTTS</b>			
14SR-83R-2-3/8	2-3/8"	1/2" tapered	130A1M
24SR-83R-3	3"	5/8" tapered	241A1M

Rubber-tipped Peens



Part Number	Diameter	Fits Rods	Fits IR Tool
<b>RUBBER-TIPPED PEENS</b>			
14SR-93R	2-3/8"	1/2" tapered	130A1M
24SR-93R	2-7/8"	5/8" tapered	241A1M



## Scaler & Needle Scaler Steels





Ingersoll Rand chisel and needle scalers are your best solutions for removing unwanted surface coatings and deposits. They're ideal for removing paint, rust, weld splatter and slag, and other materials.



INGERSOLL RAND



### Scaler Chisels

	7"		12"		18"	
	Part Number	Weight lb	Part Number	Weight lb	Part Number	Weight lb
<b>Blank</b>	<b>BLANK</b>					
	WF-14-007	0.5	WF-14-12	0.75	WF-14-18	1.25
<b>Narrow</b>	<b>NARROW</b>					
	WF-14F-7	0.5	WF-14F-12	0.75	WF-14F-18	1.25
<b>Standard Wide</b>	<b>STANDARD WIDE</b>					
	WF-14B-007	0.5	WF-14B-012	0.75	WF-14B-18	1.25
<b>2" Wide</b>	<b>2" WIDE</b>					
	WF-14C-007	0.5	WF-14C-012	0.75	WF-14C-018	1.5

### 3" Wide



7"		12"		18"	
Part Number	Weight lb	Part Number	Weight lb	Part Number	Weight lb
<b>3" WIDE</b>					
WF-14D-007	0.75	WF-14D-012	1	WF-14D-018	1.5

### Spoon



7"		12"		18"	
Part Number	Weight lb	Part Number	Weight lb	Part Number	Weight lb
<b>SPOON</b>					
WF-14A-007	0.5	WF-14A-12	0.75	WF-14A-18	1.25

### Gouge



7"		12"		18"	
Part Number	Weight lb	Part Number	Weight lb	Part Number	Weight lb
<b>GOUGE</b>					
WF-14G-6	0.5	-	-	-	-

### 2" Blade



7"		12"		18"	
Part Number	Weight lb	Part Number	Weight lb	Part Number	Weight lb
<b>2" BLADE</b>					
89940613	0.5	-	-	-	-

### 3" Blade

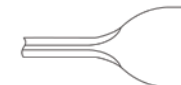

7"		12"		18"	
Part Number	Weight lb	Part Number	Weight lb	Part Number	Weight lb
<b>3" BLADE</b>					
22038749	0.75	-	-	-	-

### 2" Blade (spark-resistant)



7"		12"		18"	
Part Number	Weight lb	Part Number	Weight lb	Part Number	Weight lb
<b>2" BLADE (SPARK-RESISTANT)</b>					
22038756	0.5	-	-	-	-

CLECO



CLECO Scaler Chisels

Blank



Hex Shank Size 7"		12"		18"	
Part Number	Weight lb	Part Number	Weight lb	Part Number	Weight lb
BLANK					
PF2200-391	0.5	PF2200-391-12	0.75	PF2200-391-18	1.25

Narrow



Hex Shank Size 7"		12"		18"	
Part Number	Weight lb	Part Number	Weight lb	Part Number	Weight lb
NARROW					
PF2200-392	0.5	PF2200-392-12	0.75	PF2200-392-18	1.25

Standard Wide



Hex Shank Size 7"		12"		18"	
Part Number	Weight lb	Part Number	Weight lb	Part Number	Weight lb
STANDARD WIDE					
PF2200-393	0.5	PF2200-393-12	0.75	PF2200-393-18	1.25

2" Wide



Hex Shank Size 7"		12"		18"	
Part Number	Weight lb	Part Number	Weight lb	Part Number	Weight lb
2" WIDE					
PF2200-390	0.5	PF2200-390-12	0.75	PF2200-390-18	1.5

3" Wide

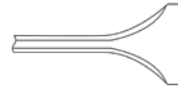

Hex Shank Size 7"		12"		18"	
Part Number	Weight lb	Part Number	Weight lb	Part Number	Weight lb
3" WIDE					
PF2200-390-3	0.75	PF2200-390-3-12	1	PF2200-390-3-18	1.5

Spoon



Hex Shank Size 7"		12"		18"	
Part Number	Weight lb	Part Number	Weight lb	Part Number	Weight lb
SPOON					
PF2200-394	0.5	PF2200-394-12	0.75	PF2200-394-18	1.25

Round Nose



Hex Shank Size 7"		12"		18"	
Part Number	Weight lb	Part Number	Weight lb	Part Number	Weight lb
ROUND NOSE					
PF2200-3231	0.5	-	-	-	-

Cape



Hex Shank Size 7"		12"		18"	
Part Number	Weight lb	Part Number	Weight lb	Part Number	Weight lb
CAPE					
PF2200-3232	0.5	-	-	-	-

CHICAGO PNEUMATIC



Chicago Pneumatic Scaler Chisels

Blank



Hex Shank Size 7"		12"		18"	
Part Number	Weight lb	Part Number	Weight lb	Part Number	Weight lb
BLANK					
CP2100-07	0.5	CP2100-12	0.75	CP2100-18	1.25

Narrow



Hex Shank Size 7"		12"		18"	
Part Number	Weight lb	Part Number	Weight lb	Part Number	Weight lb
NARROW					
CP2153-07	0.5	CP2153-12	0.75	CP2153-18	1.25

Standard Wide



Hex Shank Size 7"		12"		18"	
Part Number	Weight lb	Part Number	Weight lb	Part Number	Weight lb
STANDARD WIDE					
CP2151-07	0.5	CP2151-12	0.75	CP2151-18	1.25

2" Wide



Hex Shank Size 7"		12"		18"	
Part Number	Weight lb	Part Number	Weight lb	Part Number	Weight lb
2" WIDE					
CP2107-07	0.5	CP2107-12	0.75	CP2107-18	1.5

3" Wide

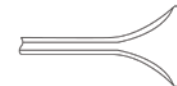

Hex Shank Size 7"		12"		18"	
Part Number	Weight lb	Part Number	Weight lb	Part Number	Weight lb
3" WIDE					
CP2142-07	0.75	CP2142-12	1	-	-

Spoon



Hex Shank Size 7"		12"		18"	
Part Number	Weight lb	Part Number	Weight lb	Part Number	Weight lb
SPOON					
CP2154-07	0.5	CP2154-12	0.75	CP2154-18	1.25

Pneumatic Tool Steels

Pneumatic Tool Steels

## Round Needle Housings



## Rectangular Needle Housings



## Needle Scaler Housings

Part Number	Description
<b>ROUND NEEDLE HOUSINGS</b>	
NS11A	With 5" (127 mm) steel needles
NS11AS	With 5" (127 mm) stainless-steel needles
NS11A7	With 7" (178 mm) extended steel needles — optional
<b>RECTANGULAR NEEDLE HOUSINGS</b>	
NS11BB	With 5" (127 mm) beryllium copper needles
NS11BS	With 5" (127 mm) stainless-steel needles
NS11B7	With 7" (178 mm) extended steel needles
<b>REPLACEMENT NEEDLES — SET OF 19 NEEDLES (3 mm)</b>	
NS11-22-19	5" (127 mm) steel needles — standard
NS11-B22-19	5" (127 mm) beryllium copper needles — optional
NS11-S22-19	5" (127 mm) stainless-steel needles — optional
NS11-122-19	7" (178 mm) extended steel needles — optional

## Bulk Needles

Part Number	Description	Quantity
<b>BULK NEEDLES</b>		
22038194	2 mm needle holder for 170PG	N/A
22038202	2 mm needle holder for 180PG	N/A
22038210	4 mm needle holder for 180PG	N/A
22038525	2 mm flat tip 7" steel	100
22038533	3 mm flat tip 5" steel	100
22038566	3 mm flat tip 7" beryllium	500
22038558	3 mm flat tip 7" beryllium	100
22038541	3 mm flat tip 7" steel	1,000
89940597	3 mm flat tip 7" steel	100
22038582	3 mm chisel tip 7" steel	1,000
22038574	3 mm chisel tip 7" steel	100
22038608	3 mm pointed tip 7" steel	1,000
22038590	3 mm pointed tip 7" steel	100
22038624	4 mm flat tip 7" steel	500
22038616	4 mm flat tip 7" steel	100
22038640	4 mm chisel tip 7" steel	500
22038632	4 mm chisel tip 7" steel	100
22038665	4 mm pointed tip 7" steel	500
22038657	4 mm pointed tip 7" steel	100



# Abrasives & Pads



## Quick Change Abrasives

Ingersoll Rand offers a complete line of 1-1/2" to 3" surface-conditioning discs designed to maximize the productivity of our grinders, while ensuring the best possible finishes.

### Quick-Change Backer Pads

Part Number	Description
<b>QUICK-CHANGE BACKER PADS</b>	
02A-MEDPD-NM	2" Medium pad no mandrel
03A-MEDPD-NM	3" Medium pad no mandrel
02A-SFTPD	2" Soft holder pad w/ 1/4" mandrel
03A-SFTPD	3" Soft holder pad w/ 1/4" mandrel
15A-MEDPD	1-1/2" Medium holder pad w/ 1/4" mandrel
02A-MEDPD	2" Medium holder pad w/ 1/4" mandrel
03A-MEDPD	3" Medium holder pad w/ 1/4" mandrel
02A-FRMPD	2" Firm holder pad w/ 1/4" mandrel
03A-FRMPD	3" Firm holder pad w/ 1/4" mandrel



### AO Series

Features	Benefits
Quick-change fastening systems	Instant disc changes; disc is centered; smooth-running
Multiple layers of backing	Works well on flat and contoured surfaces
Aggressive stock removal	Greater productivity



### AO Series Quick-Change Sanding Discs

Part Number	Description	Grit
<b>INDUSTRIAL PACKS (FLAP-TOP BOX)</b>		
15A-036AO-100	1-1/2" AO Series sanding disc	36
15A-050AO-100	1-1/2" AO Series sanding disc	50
15A-080AO-100	1-1/2" AO Series sanding disc	80
15A-120AO-100	1-1/2" AO Series sanding disc	120
15A-180AO-100	1-1/2" AO Series sanding disc	180
15A-240AO-100	1-1/2" AO Series sanding disc	240
02A-036AO-100	2" AO Series sanding disc	36
02A-050AO-100	2" AO Series sanding disc	50
02A-080AO-100	2" AO Series sanding disc	80
02A-120AO-100	2" AO Series sanding disc	120
02A-180AO-100	2" AO Series sanding disc	180
02A-240AO-100	2" AO Series sanding disc	240
03A-036AO-50	3" AO Series sanding disc	36
03A-050AO-50	3" AO Series sanding disc	50
03A-080AO-50	3" AO Series sanding disc	80
03A-120AO-50	3" AO Series sanding disc	120
03A-180AO-50	3" AO Series sanding disc	180
03A-240AO-50	3" AO Series sanding disc	240
<b>AUTOMOTIVE PACKS (SMALLER QUANTITY FLIP-TOP BOXES)</b>		
02A-036AO-25	2" AO series sanding disc	36
02A-050AO-25	2" AO series sanding disc	50
02A-080AO-25	2" AO Series sanding disc	80
02A-120AO-25	2" AO Series sanding disc	120
02A-180AO-25	2" AO Series sanding disc	180
02A-240AO-25	2" AO Series sanding disc	240
03A-036AO-25	3" AO Series sanding disc	36
03A-050AO-25	3" AO Series sanding disc	50
03A-080AO-25	3" AO Series sanding disc	80
03A-120AO-25	3" AO Series sanding disc	120
03A-180AO-25	3" AO Series sanding disc	180
03A-240AO-25	3" AO Series sanding disc	240

### ZR Series Quick-Change Sanding Discs

Features	Benefits
Variety of quick-change fastening systems	Instant disc changes; disc is centered; smooth-running
Zirconia alumina grain	Durable; rapid stock removal
Cooler-running	Reduce risk of loading; longer-lasting
2-ply construction	Work well on flat or surfaces

Part Number	Description	Grit
<b>ZR SERIES — QUICK-CHANGE SANDING DISCS</b>		
15A-036ZR-100	1-1/2" ZR Series sanding disc	36
15A-050ZR-100	1-1/2" ZR Series sanding disc	50
15A-080ZR-100	1-1/2" ZR Series sanding disc	80
15A-120ZR-100	1-1/2" ZR Series sanding disc	120
02A-036ZR-100	2" ZR Series sanding disc	36
02A-050ZR-100	2" ZR Series sanding disc	50
02A-080ZR-100	2" ZR Series sanding disc	80
02A-120ZR-100	2" ZR Series sanding disc	120
03A-036ZR-50	3" ZR Series sanding disc	36
03A-050ZR-50	3" ZR Series sanding disc	50
03A-080ZR-50	3" ZR Series sanding disc	80
03A-120ZR-50	3" ZR Series sanding disc	120
<b>AUTOMOTIVE PACKS (SMALLER QUANTITY FLIP-TOP BOXES)</b>		
02A-036ZR-25	2" ZR Series sanding disc	36
02A-050ZR-25	2" ZR Series sanding disc	50
02A-080ZR-25	2" ZR Series sanding disc	80
02A-120ZR-25	2" ZR Series sanding disc	120
03A-036ZR-25	3" ZR Series sanding disc	36
03A-050ZR-25	3" ZR Series sanding disc	50
03A-080ZR-25	3" ZR Series sanding disc	80
03A-120ZR-25	3" ZR Series sanding disc	120

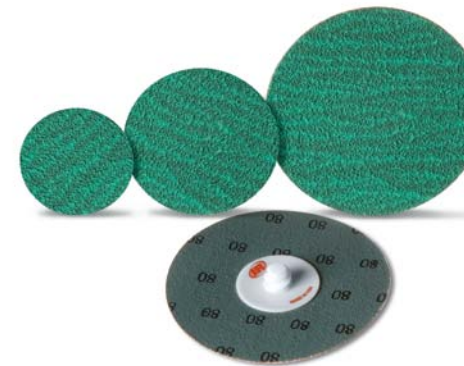

### CO Series Quick-Change Sanding Discs

Features	Benefits
Ceramic grain	Durable; rapid stock removal
Stiff, durable backing	Maintain high cut rate on edges without grain shredding and tearing
Cooler-running	Reduce risk of loading

Part Number	Description	Grit
<b>CO SERIES — QUICK-CHANGE SANDING DISCS</b>		
15A-036CO-100	1-1/2" CO Series sanding disc	36
15A-050CO-100	1-1/2" CO Series sanding disc	50
15A-080CO-100	1-1/2" CO Series sanding disc	80
15A-120CO-100	1-1/2" CO Series sanding disc	120
02A-036CO-100	2" CO Series sanding disc	36
02A-050CO-100	2" CO Series sanding disc	50
02A-080CO-100	2" CO Series sanding disc	80
02A-120CO-100	2" CO Series sanding disc	120
03A-036CO-50	3" CO Series sanding disc	36
03A-050CO-50	3" CO Series sanding disc	50
03A-080CO-50	3" CO Series sanding disc	80
03A-120CO-50	3" CO Series sanding disc	120
<b>AUTOMOTIVE PACKS (SMALLER QUANTITY FLIP-TOP BOXES)</b>		
02A-036CO-25	2" CO Series sanding disc	36
02A-050CO-25	2" CO Series sanding disc	50
02A-080CO-25	2" CO Series sanding disc	80
02A-120CO-25	2" CO Series sanding disc	120
03A-036CO-25	3" CO Series sanding disc	36
03A-050CO-25	3" CO Series sanding disc	50
03A-080CO-25	3" CO Series sanding disc	80
03A-120CO-25	3" CO Series sanding disc	120

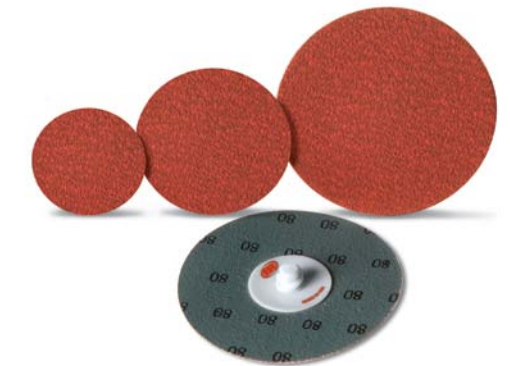



### Quick-Change Surface Prep Discs

Part Number	Description
<b>INDUSTRIAL PACKS (FLIP-TOP BOXES)</b>	
15A-CRSBR-50	1-1/2" Surface prep disc — coarse, brown
15A-MEDBR-50	1-1/2" Surface prep disc — medium, maroon
15A-VFNBR-50	1-1/2" Surface prep disc — very fine, blue
02A-CRSBR-50	2" Surface prep disc — coarse, brown
02A-MEDBR-50	2" Surface prep disc — medium, maroon
02A-VFNBR-50	2" Surface prep disc — very fine, blue
03A-CRSBR-25	3" Surface prep disc — coarse, brown
03A-MEDBR-25	3" Surface prep disc — medium, maroon
03A-VFNBR-25	3" Surface prep disc — very fine, blue
<b>AUTOMOTIVE PACKS (SMALLER QUANTITY FLIP-TOP BOXES)</b>	
02A-CRSBR-25	2" Surface prep disc — coarse, brown
02A-MEDBR-25	2" Surface prep disc — medium, maroon
02A-VFNBR-25	2" Surface prep disc — very fine, blue
03A-CRSBR-10	3" Surface prep disc — coarse, brown
03A-MEDBR-10	3" Surface prep disc — medium, maroon
03A-VFNBR-10	3" Surface prep disc — very fine, blue

### Quick-Change Quick Strip Discs

Part Number	Description
02A-CRSBS-25	2" Surface prep coating removal disc — black
03A-CRSBS-10	3" Surface prep coating removal disc — black
02A-CRSBB-25	2" Surface prep coating removal disc — blue*
03A-CRSBB-10	3" Surface prep coating removal disc — blue*
<b>AUTOMOTIVE PACKS (SMALLER QUANTITY FLIP-TOP BOXES)</b>	
02A-CRSBS-10	2" Surface prep coating removal disc — black
03A-CRSBS-5	3" Surface prep coating removal disc — black
02A-CRSBB-10	2" Surface prep coating removal disc — blue*
03A-CRSBB-5	3" Surface prep coating removal disc — blue*



\*For more aggressive applications.



Available in coarse, medium, and fine grit.

### Convenience Packs

Part Number	Description	Grit
<b>AO SERIES — CUTTING &amp; GRINDING (6-PIECE PACKS)</b>		
02A-036AO-6	2" AO Series sanding disc	36
02A-050AO-6	2" AO Series sanding disc	50
02A-080AO-6	2" AO Series sanding disc	80
02A-120AO-6	2" AO Series sanding disc	120
03A-036AO-6	3" AO Series sanding disc	36
03A-050AO-6	3" AO Series sanding disc	50
03A-080AO-6	3" AO Series sanding disc	80
03A-120AO-6	3" AO Series sanding disc	120
<b>VARIETY PACKS</b>		
02A-VARAO-6	2" AO Series sanding disc	2 ea. 36, 50, 80
03A-VARAO-6	3" AO Series sanding disc	2 ea. 36, 50, 80
02A-VARZR-6	2" ZR Series sanding disc	2 ea. 36, 50, 80
03A-VARZR-6	3" ZR Series sanding disc	2 ea. 36, 50, 80
02A-VARCO-6	2" CO Series sanding disc	2 ea. 36, 50, 80
03A-VARCO-6	3" CO Series sanding disc	2 ea. 36, 50, 80
<b>SURFACE CONDITIONING / GASKET REMOVAL (5-PIECE PACKS)</b>		
02A-VARBR-5	2" Surface prep disc	2 ea. coarse, medium 1 ea. very fine
03A-VARBR-5	3" Surface prep disc	2 ea. coarse, medium 1 ea. very fine
<b>QUICK-STRIP — PAINT &amp; CORROSION REMOVAL (3-PIECE PACKS)</b>		
02A-BSCRS-3	2" Surface prep coating removal disc — black	
<b>HIGH STRENGTH MEDIUM — BLEND &amp; BUFF</b>		
02A-MEDBB-3	2" Quick-change high-strength buffing discs	
03A-MEDBB-3	3" Quick-change high-strength buffing discs	



### Mini Tool Accessories

Part Number	Description
<b>MINI POLISHER ACCESSORIES</b>	
03H-PAD-HL	3" Hook & loop backer pad (fits polisher and RO sander)
03F-SFTWL-6	3" Hook & loop wool pad (for compounding)
03F-MEDFM-6	3" Hook & loop waffle pad white (for compounding)
03F-SFTFM-6	3" Hook & loop waffle pad yellow (for polishing)



### Mini Tool Sanding Discs

Part Number	Description	Grit
<b>3" HOOK &amp; LOOP AO PAPER</b>		
03H-040AO-50	3" Hook & loop aluminum oxide disc	40
03H-080AO-50	3" Hook & loop aluminum oxide disc	80
03H-100AO-50	3" Hook & loop aluminum oxide disc	100
03H-120AO-50	3" Hook & loop aluminum oxide disc	120
03H-180AO-50	3" Hook & loop aluminum oxide disc	180
03H-220AO-50	3" Hook & loop aluminum oxide disc	220
03H-240AO-50	3" Hook & loop aluminum oxide disc	240
03H-320AO-50	3" Hook & loop aluminum oxide disc	320
03H-360AO-50	3" Hook & loop aluminum oxide disc	360
03H-400AO-50	3" Hook & loop aluminum oxide disc	400
03H-500AO-50	3" Hook & loop aluminum oxide disc	500
03H-800AO-50	3" Hook & loop aluminum oxide disc	800





## Pads & Belts

Whatever your surface preparation needs happen to be, we offer a full range of sanding, backing, and polishing pads. Genuine Ingersoll Rand pads are specifically engineered to work at the tolerances of our powerful tools, ensuring you get the best finishes possible.

### Sanding and Polishing Pads

Part Number	Description
<b>SANDING &amp; POLISHING PADS</b>	
D94SK-228A	6-1/2" Flexible pad
6135A	8" Polishing pad, 2" thick polyester foam
<b>FLEXIBLE BACKING PADS</b>	
6130A	7" Flexible backing pad, heavy-duty
D94SK-228A	6-1/2" Flexible pad
<b>VINYL PAD</b>	
9860	6" Vinyl pad, dual-action backing pad — blister pack
<b>STRAIGHT LINE PADS</b>	
312A-A825	3-2/3" x 6-3/4" Straight line pad
315-39	Straight line pad



Firm pad



Vinyl pad



Straight line pad

Part Number	Description
<b>BACKING PADS</b>	
313A-825-7	7" Rigid backing pad, standard-duty
317A-825	3" & 5" backing pads
49095-1	5" Duck face pad
<b>VACUUM PADS</b>	
49096-1	5" Vacuum petal pattern pad
VPAD-6	6" Vacuum petal pattern pad
49694	6" Vacuum hook and loop pattern pad
<b>NON-VACUUM PADS</b>	
49094-1	5" Non-vacuum vinyl pad
49879-1	6" Non-vacuum vinyl pad
<b>WOOL POLISHING BONNET</b>	
P500-850	7" Wool polishing bonnet



Backing pads



Wool polishing bonnet

### Sanding Backing Pads

Part Number	Description
<b>SANDING PADS</b>	
49095	5" Sanding pad
49097-1	6" Sanding

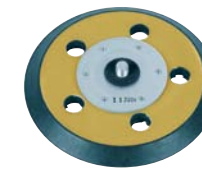

Sanding pad

### Sanding Pad Assemblies

Part Number	Description
<b>SANDING PAD ASSEMBLY</b>	
328B-825-8	8" Sanding pad assembly, dual-action backing pad, standard-duty
<b>SANDING PAD ASSEMBLIES (MEDIUM)</b>	
77A-AM825-5	5" Sanding pad assembly
77A-AM825-7	7" Sanding pad assembly
<b>SANDING PAD ASSEMBLY (FIRM)</b>	
77A-AM825-9	9" Sanding pad assembly

### Sanding Belts

Part Number	Description	Grit
<b>1/4" x 18" SANDING BELTS</b>		
LG1-SB418-60-10	Pack of 10 sanding belts	60
LG1-SB418-80-10	Pack of 10 sanding belts	80
LG1-SB418-100-10	Pack of 10 sanding belts	100
<b>1/2" x 12" SANDING BELTS</b>		
LG1-SB812-60-10	Pack of 10 sanding belts	60
LG1-SB812-80-10	Pack of 10 sanding belts	80
LG1-SB812-100-10	Pack of 10 sanding belts	100
LG1-SB818-60-10	Pack of 10 sanding belts	60
LG1-SB818-80-10	Pack of 10 sanding belts	80
LG1-SB818-100-10	Pack of 10 sanding belts	100



1/4" x 18" sanding belts



1/2" x 12" sanding belts



1/2" x 18" sanding belts

## Cutting Discs

These high quality Type 1 discs are designed for cutting through metal materials. Common applications include cutting exhaust pipes, trimming bolts, and slicing through sheet metal. The fiber reinforcement and the 1/16" thickness produces a disc that cuts quickly but remains durable. For use with any 3/8" arbor cutting tool. Maximum 25,000 RPM speed rating.

### Cutting Discs

Part Number	Size	Max RPM	Quantity
9520	3"	25,000	5
9521	3"	25,000	50



# Burs, Stones, & Collets





## Carbide Burs & Grinding Stones

Ingersoll Rand carbide burs set the industry standard for quality and are the perfect complements to our innovative grinders and finishing tools. You'll find a complete range of versatile, durable, high-precision burs, in a variety of types and sizes.

### Cylindrical-shaped Burs

Part Number	Type of Cut	Shank	Length of Cut
<b>1/8" CYLINDRICAL-SHAPED BUR*</b>			
IRSA-11	Super cut	1/4"	1/2"
<b>1/4" CYLINDRICAL-SHAPED BURS*</b>			
IRSA-1	Super cut	1/4"	5/8"
IRSA-1L	Super cut	1/4"	1"
<b>5/16" CYLINDRICAL-SHAPED BURS**</b>			
IRSA-2	Super cut	1/4"	3/4"
IRSA-2F	Fine cut	1/4"	3/4"
<b>3/8" CYLINDRICAL-SHAPED BURS**</b>			
IRSA-3	Super cut	1/4"	3/4"
IRSA-3F	Fine cut	1/4"	3/4"
<b>1/2" CYLINDRICAL-SHAPED BURS**</b>			
IRSA-5	Super cut	1/4"	1"
IRSA-5EC	Super end cut	1/4"	1"
IRSA-5F	Fine cut	1/4"	1"
<b>1/4" CYLINDRICAL-SHAPED BUR (RADIUS NOSE)*</b>			
IRSC-1	Super cut	1/4"	1"

\*Solid carbide bur.  
\*\*Solid carbide bur with steel shank.

### Tree-shaped Burs

Part Number	Type of Cut	Shank	Length of Cut
<b>1/4" TREE-SHAPED (POINTED NOSE)*</b>			
IRSF-1	Super cut	1/4"	5/8"
<b>3/8" TREE-SHAPED (POINTED NOSE)**</b>			
IRSF-3	Super cut	1/4"	3/4"
<b>1/2" TREE-SHAPED (POINTED NOSE)**</b>			
IRSF-5	Super cut	1/4"	1"
<b>5/16" TREE-SHAPED (RADIUS NOSE)**</b>			
IRSG-2	Fine cut	1/4"	3/4"

\*Solid carbide bur.  
\*\*Solid carbide bur with steel shank.

### Ball-shaped Burs

Part Number	Type of Cut	Shank	Length of Cut
<b>1/4" BALL-SHAPED BURS*</b>			
IRSD-1	Super cut	1/4"	1/4"
IRSD-3	Super cut	1/4"	3/8"

\*Solid carbide bur with steel shank.

### Cone-shaped Burs (radius nose)

Part Number	Type of Cut	Shank	Length of Cut
<b>5/16" CONE-SHAPED BUR (RADIUS NOSE)*</b>			
IRSL-2	Super cut	1/4"	3/4"
<b>3/8" CONE-SHAPED BUR (RADIUS NOSE)</b>			
IRSL-3	Super cut	1/4"	3/8"

\*Solid carbide bur with steel shank.

### Multi-shaped Grinding Stone

Part Number	Shank
<b>MULTI-SHAPED GRINDING STONE*</b>	
9800	1/4"

\*Solid in-case pack quantity of 6.

## Carbide Grinding Bur Kits

Bur Style	Shank	Head Diameter
<b>1412TiN KITS</b>		
Cylindrical	1/4"	1/2"
Ball-nosed cylindrical	1/4"	1/2"
Ball-nosed tree	1/4"	1/2"
Ball-nosed cone	1/4"	1/2"
Pointed tree	1/4"	1/2"
Ball	1/4"	1/2"
<b>1438TiN KITS</b>		
Cylindrical	1/4"	3/8"
Ball-nosed cylindrical	1/4"	3/8"
Ball-nosed tree	1/4"	3/8"
Ball-nosed cone	1/4"	3/8"
Pointed tree	1/4"	3/8"
Ball	1/4"	3/8"
<b>614TiN KITS</b>		
Cylindrical	1/4"	3/8"
Ball-nosed cylindrical	1/4"	3/8"
Ball-nosed tree	1/4"	3/8"
Cylindrical	1/4"	1/2"
Ball-nosed cylindrical	1/4"	1/2"
Ball-nosed tree	1/4"	1/2"
<b>618TiN KITS</b>		
Cylindrical	1/8"	1/4"
Ball-nosed cylindrical	1/8"	1/4"
Ball-nosed tree	1/8"	1/4"
Cylindrical	1/8"	1/8"
Ball-nosed cylindrical	1/8"	1/8"
Ball-nosed tree	1/8"	1/8"
<b>1814TiN KITS</b>		
Cylindrical	1/8"	1/4"
Ball-nosed cylindrical	1/8"	1/4"
Ball-nosed tree	1/8"	1/4"
Ball-nosed cylindrical	1/8"	1/4"
Pointed tree	1/8"	1/4"
Ball	1/8"	1/4"
<b>1816TiN KITS</b>		
Cylindrical	1/8"	1/16"
Ball-nosed cylindrical	1/8"	3/32"
Ball-nosed tree	1/8"	1/8"
Ball-nosed cone	1/8"	1/8"
Pointed tree	1/8"	1/8"
Ball	1/8"	3/32"



Bur Style	Shank	Head Diameter
<b>1818TiN KITS</b>		
Cylindrical	1/8"	1/8"
Ball-nosed cylindrical	1/8"	1/8"
Ball-nosed tree	1/8"	1/8"
Ball-nosed Cone	1/8"	1/8"
Pointed tree	1/8"	1/8"
Ball	1/8"	1/8"
<b>814TiN BOXED KITS</b>		
Cylindrical	1/4"	1/2 & 3/8"
Ball-nosed cylindrical	1/4"	1/2 & 3/8"
Ball	1/4"	1/2 & 3/8"
Ball-nosed tree	1/4"	1/2 & 3/8"

This 8-piece carbide bur kit contains the most popular sizes in a durable storage box.

#### M30TiN BOXED KIT

This 30-piece carbide bur mega set covers a wide range of applications. The kit includes each available bur with 1/8" and 1/4" shank with various head diameters.

*NOTE: Burs have a maximum operating speed of 40,000 rpm.*



814TiN  
Boxed Kit



M30TiN  
Boxed Kit

## Collets

Part Number	Size	Where Used
<b>TAPPER COLLETS</b>		
2U-103-1/4	1/4"	Tappers
4U-103-1/2	1/2"	Tappers
<b>DIE GRINDER COLLETS</b>		
DG110-700-6MM	6 mm	Metric die grinder
DG110-700-G2	1/8"	Die grinder
301-700C	1/8"	3102 and 3108 Series
DG110-700-G4	1/4"	Die grinder
G160HD-700-1/4	1/4"	Die and horizontal grinders
307-700	1/4"	3102 and 3108 series
DG120-700-G6	3/8"	Die grinder

Part Number	Size	Description	Where Used
<b>HORIZONTAL GRINDER COLLET BODY ASSEMBLY</b>			
DG220-A290-G4	1/4"	Replacement collet body assembly	All grinder models ending in G4, except C Series and G1 Series; Pro Series (61H)

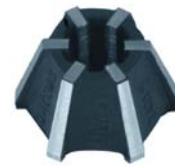

DG110-700-G2



DG120-700-G6



DG220-A290-G6



# Air Reciprocating Saw Blades





## Air Reciprocating Saw Blades

Ingersoll Rand Air Reciprocating Saw Blades feature Bi-Metal technology, a solid-state diffusion process that applies high-speed steel to both edges of the backing material, increasing the contact area by 170%. This technology, coupled with a new tooth profile, reduces the frictional heat generated during the cutting process resulting in enhanced overall cutting performance.



Part Number	Description	TPI
P4FS-6	6-Pack — Fine standard pitch air recip saw blade	32
P4CS-6	6-Pack — Coarse standard pitch air recip saw blade	34
P4EV-6	6-Pack — Extra coarse variable pitch air recip saw blade	14/18
P4FS-20	20-Pack — Fine standard pitch air recip saw blade	32
P4CS-20	20-Pack — Coarse standard pitch air recip saw blade	24
P4EV-20	20-Pack — Extra coarse variable pitch air recip saw blade	14/18
P4FS-50	50-Pack — Fine standard pitch air recip saw blade	32
P4CS-50	50-Pack — Coarse standard pitch air recip saw blade	24
P4EV-50	50-Pack — Extra coarse variable pitch air recip saw blade	14/18

*Ingersoll Rand blades can be used with all standard 1/2" shank air reciprocating saws.*



# Drill & Nutrunner Bits



## Bits

Our quick change driver bits and related accessories are the perfect complement to our line of fastening tools. All sets come in ballistic nylon accessory cases.

### 1/4" Hex Bit Sets

Part Number	Description
<b>HXNSK-10E 10-PIECE 2" POWER BIT SAE NUT SETTER KIT</b>	
<b>SIZES</b>	5/32", 3/16", 7/32", 1/4", 9/32", 5/16", 11/32", 3/8", 7/16", 1/2"
<b>FEATURES</b>	<ul style="list-style-type: none"> <li>Quick change hex drive for easy removal</li> <li>Top-of-the-line magnetics for increased bit retention</li> <li>Full assortment of sizes to be used on any project</li> </ul>
<b>HXNSK-9M 9-PIECE 2" POWER BIT METRIC NUT SETTER KIT</b>	
<b>SIZES</b>	5.5 mm, 6 mm, 7 mm, 8 mm, 9 mm, 10 mm, 11 mm, 12 mm, 13 mm
<b>FEATURES</b>	<ul style="list-style-type: none"> <li>Quick change hex drive for quick and easy removal</li> <li>Top-of-the-line magnetics for increase bit retention</li> <li>Full assortment of sizes to be used on any project</li> </ul>
<b>HXALK-9E 9-PIECE 2" MAGNETIC POWER BIT SAE ALLEN BIT KIT</b>	
<b>SIZES</b>	1/16", 5/64", 3/32", 7/64", 1/8", 9/64", 5/32", 3/16", 1/4"
<b>FEATURES</b>	<ul style="list-style-type: none"> <li>Quick change hex drive for quick and easy removal</li> <li>Made of high quality industrial-grade steel</li> <li>Magnetic bit increases strength of hold on screw</li> </ul>
<b>HXALK-9M 9-PIECE 2" MAGNETIC POWER BIT METRIC ALLEN BIT KIT</b>	
<b>SIZES</b>	1.5 mm, 2 mm, 2.5 mm, 3 mm, 4 mm, 5 mm, 6 mm, 7 mm, 8 mm
<b>FEATURES</b>	<ul style="list-style-type: none"> <li>Quick change hex drive for quick and easy removal</li> <li>Made of high quality industrial-grade steel</li> <li>Magnetic bit increases strength of hold on screw</li> </ul>
<b>HXSQS-2* 2-PIECE POWER BIT SOCKET ADAPTER SET</b>	
<b>SIZES</b>	1/4" square drive adapter, 3/8" square drive adapter
<b>FEATURES</b>	<ul style="list-style-type: none"> <li>Allows addition of sockets to a driver</li> <li>Magnetic tip allows for great hold on sockets</li> </ul>
<b>HXCMK-20 20-PIECE POWER BIT COMBO KIT</b>	
<b>PIECES</b>	Pieces (2) #1 Phillips, #2 Phillips, #3 Phillips 5/32", 3/16", 1/4", 7/32" power Allen bits #6, #8, #10 slotted driver bits T8, T9, T10, T15, T20, T25, T30 Torx Res driver bits (2) #2 Phillips 3" long
<b>FEATURES</b>	<ul style="list-style-type: none"> <li>Assortment of bits for completion</li> <li>3" Phillips bit for hard-to-reach places</li> <li>Made of high quality industrial-grade steel</li> </ul>



### 1/4" Hex Bit Sets

Part Number	Description
<b>HXCMK-30 30-PIECE POWER BIT COMBO KIT</b>	
<b>PIECES</b>	Pieces (2) #1 Phillips, (2) #2 Phillips, (2) #3 Phillips 1/8", 9/64", 5/32", 3/16", 1/4", 7/32" Allen bits #6, (2) #8, #10 slotted driver bits T8, T9, T10, T15, T20, T25, T30, T40 Torx Res driver bits 1/4" and 3/8" magnetic square drive adapters 1/4", 3/8", 5/16" magnetic nut setters #2 Phillips 3" long
<b>FEATURES</b>	<ul style="list-style-type: none"> <li>Heat-treated, shock-resistant tool steel for optimum durability</li> <li>Assortment of bits for completion of all tasks</li> <li>Manufactured using the most advanced processes</li> </ul>
<b>HXTXK-11 11-PIECE POWER BIT TORX DRIVE SET</b>	
<b>SIZES</b>	T5, T6, T7, T8, T9, T10, T15, T20, T25, T30, T40
<b>FEATURES</b>	<ul style="list-style-type: none"> <li>Tamper-resistant</li> <li>Quick change hex drive for easy removal</li> <li>Made of high quality industrial-grade steel</li> </ul>
<b>BHS-3* 3-PIECE BIT HOLDER SET</b>	
<b>SIZES</b>	2" and 3" magnetic bit holders, 3" drive guide
<b>FEATURES</b>	<ul style="list-style-type: none"> <li>Drive guide for easy screw insertion</li> <li>Magnetic tips for quick change of standard bits</li> <li>Heat-treated, shock-resistant tool steel for optimum durability</li> </ul>

\*This set does not include case. Comes in blister pack.



### 1/4" Individual Hex Bits

Part Number	Description
<b>NUT SETTERS</b>	
<b>STANDARD (SAE) 2" POWER BITS</b>	
5/32HXNS-E	5/32" power bit magnetic nut setter
3/16HXNS-E	3/16" power bit magnetic nut setter
7/32HXNS-E	7/32" power bit magnetic nut setter
1/4HXNS-E	1/4" power bit magnetic nut setter
9/32HXNS-E	9/32" power bit magnetic nut setter
5/16HXNS-E	5/16" power bit magnetic nut setter
11/32HXNS-E	11/32" power bit magnetic nut setter
3/8HXNS-E	3/8" power bit magnetic nut setter
7/16HXNS-E	7/16" power bit magnetic nut setter
1/2HXNS-E	1/2" power bit magnetic nut setter
<b>METRIC 2" POWER BITS</b>	
7HXNS-M	7 mm power bit magnetic nut setter
8HXNS-M	8 mm power bit magnetic nut setter
9HXNS-M	9 mm power bit magnetic nut setter
10HXNS-M	10 mm power bit magnetic nut setter
11HXNS-M	11 mm power bit magnetic nut setter
12HXNS-M	12 mm power bit magnetic nut setter
13HXNS-M	13 mm power bit magnetic nut setter





### 1/4" Individual Hex Bits

Part Number	Description
<b>ALLEN BITS</b>	
<b>STANDARD (SAE) 1" STANDARD BITS</b>	
1/8DBAL-E	1/8" Allen drill bit
9/64DBAL-E	9/64" Allen drill bit
5/32DBAL-E	5/32" Allen drill bit
3/16DBAL-E	3/16" Allen drill bit
1/4DBAL-E	1/4" Allen drill bit
<b>STANDARD (SAE) 2" POWER BITS</b>	
1/16HXAL-E	1/16" power magnetic allen bit
5/64HXAL-E	5/64" power magnetic allen bit
3/32HXAL-E	3/32" power magnetic allen bit
7/64HXAL-E	7/64" power magnetic allen bit
1/8HXAL-E	1/8" power magnetic allen bit
9/64HXAL-E	9/64" power magnetic allen bit
5/32HXAL-E	5/32" power magnetic allen bit
3/16HXAL-E	3/16" power magnetic allen bit
7/32HXAL-E	7/32" power magnetic allen bit
1/4HXAL-E	1/4" power magnetic allen bit
<b>METRIC 2" POWER BITS</b>	
1.5HXAL-M	1.5 mm power magnetic Allen bit
2HXAL-M	2 mm power magnetic Allen bit
2.5HXAL-M	2.5 mm power magnetic Allen bit
3HXAL-M	3 mm power magnetic Allen bit
4HXAL-M	4 mm power magnetic Allen bit
4HXAL-M	4 mm power magnetic Allen bit
5HXAL-M	5 mm power magnetic Allen bit
6HXAL-M	6 mm power magnetic Allen bit
7HXAL-M	7 mm power magnetic Allen bit
8HXAL-M	8 mm power magnetic Allen bit
<b>HEX TO SQUARE ADAPTERS</b>	
1/4HXSQAD	1/4" power bit magnetic square drive adapter
3/8HXSQAD	3/8" power bit magnetic square drive adapter
<b>MAGNETIC BIT HOLDERS AND DRIVE GUIDES</b>	
2HXMGBH	2" magnetic bit holder
3HXMGBH	3" magnetic bit holder
3HXDRGD	3" drive guide
<b>PHILLIPS BITS</b>	
<b>1" STANDARD BITS</b>	
1DBPH	1 Philips drill bit
2DBPH	2 Philips drill bit
<b>2" POWER BITS</b>	
1HXPH	1 Phillips driver bit
2HXPH	2 Phillips driver bit
3HXPH	3 Phillips driver bit



### 1/4" Individual Hex Bits

Part Number	Description
<b>3" POWER BITS</b>	
2HXP3I	2 Phillips 3" long
<b>SLOTTED BITS</b>	
<b>1" STANDARD BITS</b>	
6DBSL	6 slotted drill bit
8DBSL	8 slotted drill bit
<b>2" POWER BITS</b>	
6HXSL	6 slotted driver bit
8HXSL	8 slotted driver bit
10HXSL	10 slotted driver bit
<b>TORX BITS TAMPER-RESISTANT T8 ON UP</b>	
<b>1" STANDARD BITS</b>	
T10DBTXR	T10 Torx res drill bit
T15DBTXR	T15 Torx res drill bit
T20DBTXR	T20 Torx res drill bit
T25DBTXR	T25 Torx res drill bit
<b>TORX BITS TAMPER-RESISTANT T8 ON UP</b>	
<b>2" POWER BITS</b>	
T5HXTX	T5 Torx driver bit
T6HXTX	T6 Torx driver bit
T7HXTXR	T7 Torx res driver bit
T8HXTXR	T8 Torx res driver bit
T9HXTXR	T9 Torx res driver bit
T10HXTXR	T10 Torx res driver bit
T15HXTXR	T15 Torx res driver bit
T20HXTXR	T20 Torx res driver bit
T25HXTXR	T25 Torx res driver bit
T30HXTXR	T30 Torx res driver bit
T40HXTXR	T40 Torx res driver bit

Part Number	Description	Point Size	Quantity
<b>PHILLIPS INSERT BIT</b>			
XPB073	Phillips bits for 1/4" insert holders	3	5
<b>POZIDRIV™ INSERT BIT</b>			
XPZB072	Pozidriv™ bits for 1/4" insert holders	2	5

Part Number	Description
<b>DETENTED BITS</b>	
XF167	#5 slotted head bit 1-15/16"
XF1612	#12 slotted head bit 1-15/16"

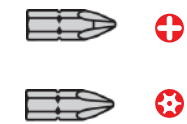

Drill & Nutrunner Bits

Drill & Nutrunner Bits

### 1/4" Individual Hex Bits

Part Number	Description	Quantity
<b>PHILLIPS BITS</b>		
XP161	1pt 1-15/16" Detented Phillips Bit	2
XP162	2pt 1-15/16" Detented Phillips Bit	2
XP221	1pt 2-3/4" Detented Phillips Bit	2
XP222	2pt 2-3/4" Detented Phillips Bit	2
XP223	3pt 2-3/4" Detented Phillips Bit	2
<b>REED AND PRINCE HEAD BIT</b>		
XRP161	1pt 1-15/16" Detented Phillips Bit	1
<b>HEX SOCKET HEAD BITS</b>		
HX135	1-15/16" 5/32" Hex	2
HX138	1-15/16" 1/4" Hex	2

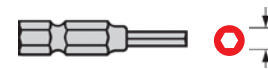

Part Number	Description	Length
<b>POWER BITS FOR RECESSED HEAD SCREWS</b>		
P283-7	3pt Phillips Bit	3-1/2"
P284-7	4pt Phillips Bit	3-1/2"
P363-7	3pt Phillips Bit	4-1/2"
HX206-7	3/16" Hex Allen Head	3-1/2"
HX207-7	7/32" Hex Allen Head	3-1/2"
HX208-7	1/4" Hex Allen Head	3-1/2"
HX2010-7	5/16" Hex Allen Head	3-1/2"
HX2012-7	3/8" Hex Allen Head	3-1/2"

Part Number	Description	Quantity
<b>POWER SQUARE INSERT BITS*</b>		
SPB082-5	2pt Phillips Bit	5
SPB083-5	3pt Phillips Bit	5
SPB084-5	4pt Phillips Bit	5

### Drill Bits & Accessories

No matter what you're drilling needs may be, count on Ingersoll Rand for the bits you require to get the job done. We offer a variety of drill bit sets of different material compositions to allow you the flexibility to match the bit to your specific job.

#### Drill Bit Sets

Part Number	Description
<b>BLACK OXIDE BITS</b>	
<b>DBKBO-20E</b>	<b>20-PIECE FRACTIONAL JOBBER LENGTH DRILL BIT SET</b>
These bits are designed for general-purpose, heavy-duty drilling through carbon and alloy steels, aluminum, soft cast iron wood, wood composites, and plastics.	
<b>SIZES</b>	(2) 1/16", (2) 5/64", (2) 3/32", (2) 7/64", (2) 1/8", 9/64", 5/32", 11/64", 3/16", 7/32", 1/4", 5/16", 3/8", 7/16", 1/2"
<b>FEATURES</b>	<ul style="list-style-type: none"> <li>• High-quality black oxide finish</li> <li>• Made with high-speed steel</li> <li>• Fully ground for superior quality</li> </ul>
<b>TITANIUM COATED BITS</b>	
<b>DBKTI-20E</b>	<b>20-PIECE TITANIUM FRACTIONAL JOBBER LENGTH DRILL BIT SET</b>
These bits dramatically reduce heat and friction, making them last many times longer than other bits. Titanium bits are designed for repetitive heavy-duty drilling through common stainless steels, carbon and alloy steels, aluminum, soft cast iron, wood, wood composites, and plastics.	
<b>SIZES</b>	(2) 1/16", (2) 5/64", (2) 3/32", (2) 7/64", (2) 1/8", 9/64", 5/32", 11/64", 3/16", 7/32", 1/4", 5/16", 3/8", 7/16", 1/2"
<b>FEATURES</b>	<ul style="list-style-type: none"> <li>• Titanium coating for increased protection</li> <li>• Made with high-speed steel</li> <li>• Fully ground for superior quality</li> </ul>
<b>COBALT BITS</b>	
<b>DBKCB-20E</b>	<b>20-PIECE COBALT FRACTIONAL JOBBER LENGTH DRILL BIT SET</b>
These bits withstand high temperature drilling applications for extended periods of time. They're designed for heavy-duty drilling through hardened stainless steels, cast iron, and titanium.	
<b>SIZES</b>	(2) 1/16", (2) 5/64", (2) 3/32", (2) 7/64", (2) 1/8", 9/64", 5/32", 11/64", 3/16", 7/32", 1/4", 5/16", 3/8", 7/16", 1/2"
<b>FEATURES</b>	<ul style="list-style-type: none"> <li>• Integrated cobalt for maximum protection and durability</li> <li>• Fully ground for superior quality</li> </ul>

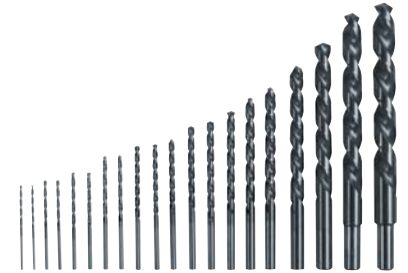
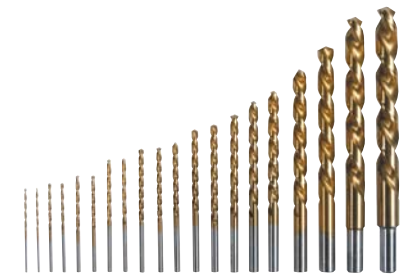
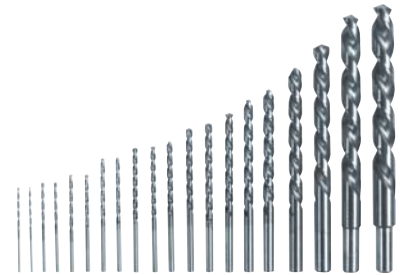

### Drill Bit Sets

Part Number	Description
<b>SDKTI-3E</b>	<b>3-PIECE STEP DRILL SET</b>
<b>SIZES</b>	1/8" – 1/2" 1/32" increments, 3/16" – 1/2" 1/16" increments, 1/4" – 3/4" 1/16" increments
<b>FEATURES</b>	<ul style="list-style-type: none"> <li>• 1/32" and 1/16" increments for accurately rounded and smooth holes</li> <li>• Titanium-coated to increase working life</li> <li>• Ideal for drilling repetitive holes in steel, copper, brass, plastic, plexiglas, and other materials</li> </ul>
<b>DCCMK-28E</b>	<b>28-PIECE DRILL / DRIVE BIT COMBO SET</b>
<b>PIECES</b>	1/16", 3/32", 1/8", 5/32", 3/16", 7/32", 1/4", 3/8" Fractional Jobber Length Drill Bit #6, #8 Slotted Driver Bits T10, T15, T20, T25 Torx Res Drill Bit 1/8", 9/64", 5/32", 3/16", 1/4" Allen Drill Bits 2" Magnetic Bit Holder 3/8" Power Bit Magnetic Square Drive Adapter 1/4", 5/16", 3/8" Power Bit Magnetic Nut Setter
<b>FEATURES</b>	• Multiple drill bits and driver bits to allow completion of all tasks



### Individual Drill Bits

Part Number	Description
<b>JOBBER LENGTH DRILL BITS</b>	
<b>BLACK OXIDE</b>	<b>TITANIUM</b> <b>COBALT</b>
1/16DBBO-E	1/16DBTI-E    1/16DBCBC-E    1/16" fractional jobber length drill bit
5/64DBBO-E	5/64DBTI-E    5/64DBCBC-E    5/64" fractional jobber length drill bit
3/32DBBO-E	3/32DBTI-E    3/32DBCBC-E    3/32" fractional jobber length drill bit
7/64DBBO-E	7/64DBTI-E    7/64DBCBC-E    7/64" fractional jobber length drill bit
1/8DBBO-E	1/8DBTI-E    1/8DBCBC-E    1/8" fractional jobber length drill bit
9/64DBBO-E	9/64DBTI-E    9/64DBCBC-E    9/64" fractional jobber length drill bit
5/32DBBO-E	5/32DBTI-E    5/32DBCBC-E    5/32" fractional jobber length drill bit
11/64DBBO-E	11/64DBTI-E    11/64DBCBC-E    11/64" fractional jobber length drill bit
3/16DBBO-E	3/16DBTI-E    3/16DBCBC-E    3/16" fractional jobber length drill bit
7/32DBBO-E	7/32DBTI-E    7/32DBCBC-E    7/32" fractional jobber length drill bit
1/4DBBO-E	1/4DBTI-E    1/4DBCBC-E    1/4" fractional jobber length drill bit
5/16DBBO-E	5/16DBTI-E    5/16DBCBC-E    5/16" fractional jobber length drill bit
3/8DBBO-E	3/8DBTI-E    3/8DBCBC-E    3/8" fractional jobber length drill bit
7/16DBBO-E	7/16DBTI-E    7/16DBCBC-E    7/16" fractional jobber length drill bit
1/2DBBO-E	1/2DBTI-E    1/2DBCBC-E    1/2" fractional jobber length drill bit
<b>STEP DRILL BITS</b>	
1/8-1/2SD-E	1/8" – 1/2" in 1/32" increments
3/16-1/2SD-E	3/16" – 1/2" in 1/16" increments
1/4-3/4SD-E	1/4" – 3/4" in 1/16" increments

### Drill Adapters

Part Number	Thread Size	Morse Taper Number	Drive Size
<b>SQUARE DRIVE ADAPTER</b>			
ROH-P212-3/8	3/8" x 24	–	3/8"
<b>SOCKET ADAPTERS</b>			
R4J-214 3 3/4"	–	3	3/4"
R5SM-214	–	5	1"
<b>QUICK CHANGE ADAPTER</b>			
ROH-A925-4	3/8" x 24	–	1/4"



### Drill Chucks

Part Number	Chuck Size	Thread Size	Corresponding Chuck Key
<b>DRILL CHUCKS</b>			
7802-99	0 – 3/8"	3/8" x 24	R00B2J70-J253
7803-99	0 – 1/2"	3/8" x 24	R1T-J253
R1N-99A	0 – 1/2"	1/2" x 20	–
<b>KEYLESS CHUCKS</b>			
728-99-KC5	0 – 3/8" Keyless	3/8" x 24	–
728-99-KC8	0 – 1/2" Keyless	3/8" x 24	–
<b>STANDARD-DUTY CHUCKS</b>			
7801-99-6	0 – 3/8" Standard-duty	3/8" x 24	728N-253
7806-99-8	0 – 1/2" Standard-duty	3/8" x 24	728N-253
<b>MEDIUM-DUTY CHUCKS</b>			
ROH-99	0 – 1/4" Medium-duty	3/8" x 24	R1H-J253
<b>HEAVY-DUTY CHUCKS</b>			
6A-99	0 – 3/8" Heavy-duty	3/8" x 24	R0J-J253
R00A-99	0 – 1/4" Heavy-duty	3/8" x 24	R00A-J253
R0K-99	5/64" – 1/2" Heavy-duty	3/8" x 24	R1T-J253



Part Number	Drive Size (female)	Hex Chuck Size (female)
<b>POWER QUICK CHANGE CHUCKS</b>		
2U-A925-4	3/8"	1/4"
502-A925-7	3/8"	7/16"
4U-A925-7	1/2"	7/16"



Drill & Nutrunner Bits

Drill & Nutrunner Bits



## Large Drill Accessories

Part Number	Description	For Use With
<b>SQUARE DRIVE SOCKET ADAPTER</b>		
DE-215A	1/2" Square drive socket adapter	Series 22
<b>CHUCKS &amp; NUTS</b>		
DE-99C	3-jaw key chuck	Series 22
T05-99A	3-jaw key chuck	Series 2X
T12-347	Chuck nut	Series 3S & 33S
TA-461	Nut	Series 551S
<b>MORSE TAPER SOCKET</b>		
DE-323A-2 #	2 Morse taper socket	Series 22
<b>WOOD BIT CHUCKS &amp; ACCESSORIES</b>		
K-27	Wood bit chuck wrench	Series 2X & 22
R33SW-151-1/2	Wood bit chuck	Series 3S
TA-A291	Wood bit chuck assembly	Series 551S
<b>LARGE DRILL ACCESSORIES</b>		
TC-365	Suspension ring	Series 3S & 33S



DE-215A



DE-99C

T05-99A

T12-347

TA-461



DE-323A-2



R33SW-151-1/2

K-27



TC-365

## Nutrunner Bits and Accessories

Ingersoll Rand nutrunner bits and accessories are designed to enhance the productivity and performance of your light assembly tools. These rugged nutrunner bits are available in a variety of sizes to satisfy all your fastening needs.

### Vacuum Pick-Up Sleeves

Part Number	Complementing Bit Part Number	Inside Diameter in (mm)	Outside Diameter in (mm)
<b>VACUUM PICK-UP SLEEVES</b>			
DLS2120	DLB2122-10	.079" (2.0)	.138" (3.5)
DLS2122	DLB2122-10	.098" (2.5)	.138" (3.5)
DLS2123	DLB2122-10	.106" (2.7)	.138" (3.5)
DLS2124	DLB2122-10	.122" (3.1)	.138" (3.5)
DLS2125	DLB2124-10	.130" (3.3)	.177" (4.5)
DLS2126	DLB2124-10	.138" (3.5)	.177" (4.5)
DLS2127	DLB2124-10	.146" (3.7)	.177" (4.5)
DLS2128	DLB2126-10	.158" (4.0)	.177" (4.5)
DLS2129	DLB2126-10	.165" (4.2)	.212" (5.5)
DLS2130	DLB2126-10	.177" (4.5)	.212" (5.5)
DLS2131	DLB2128-10, DLB2130-10, XP161, XRP161	.185" (4.7)	.212" (5.5)
DLS2132	DLB2128-10, DLB2130-10, XP161, XRP161	.201" (5.1)	.212" (5.5)
DLS2133	DLB2128-10, DLB2130-10, XP161, XRP161	.209" (5.3)	.256" (6.5)
DLS2134	DLB2128-10, DLB2130-10, XP161, XRP161	.221" (5.6)	.256" (6.5)
EL0410BC-53	DLB2128-10, DLB2130-10, XP161, XRP161	.240" (6.1)	.267" (7.0)

For use with DC electric screwdriver models EL0410BC and EL1007BC.

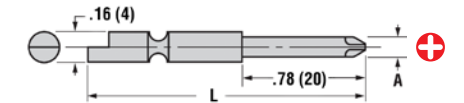

### Slotted Screwdriver Bits

Part Number (quantity 10)	Point Size	"A" Diameter in (mm)	"L" Length	Screw Size Range	Quantity
<b>DETENTED BITS</b>					
DLB2120-10	0	.069" (1.753)	1.7"	0 - 1	10
DLB2121-10	0	.069" (1.753)	2.5"	0 - 1	10
DLB2122-10	00	.074" (1.880)	1.7"	00 - 0	10
DLB2123-10	00	.077" (1.956)	2.5"	00 - 0	10
DLB2124-10	0	.096" (2.438)	1.7"	0 - 1	10
DLB2125-10	0	.096" (2.438)	2.5"	0 - 1	10
DLB2126-10	1	.117" (2.972)	1.7"	2 - 4	10
DLB2127-10	1	.118" (2.997)	2.5"	2 - 4	10
DLB2128-10	1	.156" (3.962)	1.7"	2 - 4	10
DLB2129-10	1	.157" (3.988)	2.5"	2 - 4	10
DLB2130-10	2	.156" (3.962)	1.7"	5 - 10	10
DLB2131-10	2	.157" (3.988)	2.5"	5 - 10	10
DLB2132-10	3	.235" (5.969)	1.7"	10 - 1/4	10

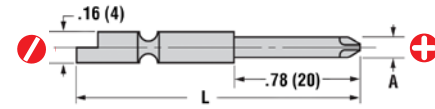

Part Number	T Size	"A" Diameter in (mm)	"L" Length	Screw Size Range	Quantity
<b>SLOT BITS</b>					
DLB2220-10	0.012	.078" (1.981)	1.7"	00 - 0	10
DLB2221-10	0.012	.097" (2.464)	1.7"	00 - 0	10
DLB2222-10	0.016	.116" (2.946)	1.7"	0 - 2	10
DLB2223-10	0.02	.157" (3.988)	1.7"	2 - 4	10
DLB2224-10	0.026	.196" (4.987)	1.7"	3 - 5	10

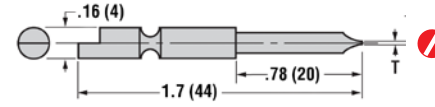

Part Number	Srew Size	"H" Hex Size in (mm)	"L" Length	Use Diagram	Quantity
<b>HEXAGON, MALE AND FEMALE</b>					
DLB2321-10	0.12	.06"	(1.5) 1.7"	Male	10
DLB2322-10	0.16	.08"	(2) 1.7"	Male	10
DLB2323-10	0.24	.12"	(3) 1.7"	Male	10
DLB2324-10	0.31	.16"	(4) 1.7"	Male	10
DLB2420-10	-	.09"	(2.3) 1.7"	Female	10
DLB2421-10	-	.10"	(2.5) 1.7"	Female	10
DLB2422-10	-	.12"	(3) 1.7"	Female	10
DLB2423-10	0.08	.16"	(4) 1.7"	Female	10
DLB2424-10	0.09	.18"	(4.5) 1.7"	Female	10
DLB2425-10	0.1	.20"	(5) 1.7"	Female	10
DLB2426-10	0.12	.22"	(5.5) 1.7"	Female	10

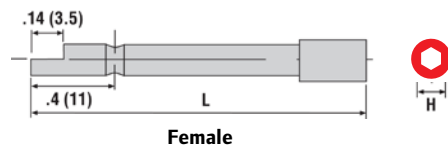
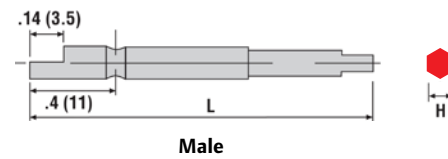

### Screwdriver and Nutrunner Accessories

Part Number	Description
<b>BITS WITH ROTATING FINDERS*</b>	
XR306	#6 slotted head bit
XR308	#8 slotted head bit
XR3010	#10 slotted head power bit
XR3012	#12 slotted head power bit

\*For use with all screwdriver models.

Part Number	Description	Size
<b>SHAKER BOXES</b>		
DLW3402	Round metal box	3-15/16" diameter
DLW3602	Rectangular plastic box	5-1/2" x 3-7/8"
DLW3802	Rectangular plastic box	6-11/16" x 4-7/8"

Part Number	Bit Size	Square Driver Size
<b>POWER SCREWDRIVER ADAPTERS</b>		
2U-812	5/16" Square	3/8"
4U-812	5/16" Square	1/2"

Part Number	Description
<b>DETENTED NON-ROTATING FINDERS</b>	
F167F1	Non-rotating finder for XF167
F1612F1	Non-rotating finder for XF1612

Part Number	Description	For Use With
<b>INSERT BIT HOLDERS</b>		
M631-4	Magnetic	All screwdriver models
RX2-631-4	Non-magnetic	All screwdriver models
DLW-4100	Slotted bit holder	EL0109B

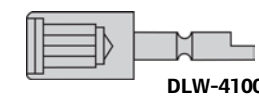
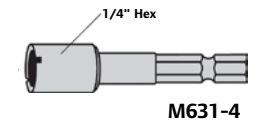



# Spring Balancers



## Spring Balancers

Featuring **gravity-free** effect on intermediate-duty, heavy-duty, and super-duty models to allow users to move tool with minimal effort along cable travel. Experience the effect of tool float.





### Hose Reel Balancers

0.875 to 5.5 lb Capacity

**Features**

- Aluminum body
- Polyurethane hose
- Adjustable capacity
- Adjustable stroke limiting device
- Designed for one-way shutoff operation



					
Model	lb (kg)	ft (m)	lb (kg)	NPT in	cfm
<b>BHR SERIES</b>					
BHR-8	2.57 (1.17)	4-1/4" (1295)	0.9 – 1.7 (0.3 – 0.7)	1/4"	18.4
BHR-15	2.6 (1.2)	4-1/4" (1295)	1.5 – 3.3 (0.6 – 1.5)	1/4"	18.4
BHR-25	2.9 (1.34)	4-1/4" (1295)	2.6 – 5.5 (1.1 – 2.4)	1/4"	18.4



### Light-Duty Balancers

0.9 to 6.6 lb Capacity

**Features**

- Rugged construction, cast aluminum body
- Stainless-steel cable; nylon cable option available for the 2.2 lb (1 kg) capacity model; order BLD1/P for this option
- Adjustable capacity
- Adjustable stroke limiting device
- Cable guide in anti-friction material
- Upper suspension shackle included on balancer for ease of installation



			
Model	lb (kg)	ft (m)	lb (kg)
<b>BLD SERIES</b>			
BLD1	1.3 (0.6)	5.2' (1600)	0.9 – 2.2 (0.4 – 1)
BLD2	1.3 (0.6)	5.2' (1600)	2.2 – 4.4 (1 – 2)
BLD3	1.3 (0.7)	5.2' (1600)	4.4 – 6.6 (2 – 3)



### Medium-Duty Short Cable Balancers

2.2 to 17.6 lb Capacity

**Features**

- Rugged construction, cast aluminum body
- Stainless-steel cable
- Adjustable capacity
- Safety device against load dropping due to the spring breakage (>3 kg); not available on model BMDS-2
- Adjustable stroke limiting device
- Cable guide in anti-friction material
- Upper suspension shackle included on balancer for ease of installation



			
Model	lb (kg)	ft (m)	lb (kg)
<b>BMD SERIES</b>			
BMDS-2	4.4 (2)	6.5' (2000)	2.2 – 5.5 (1 – 2.5)
BMDS-4	4.4 (2)	6.5' (2000)	4.4 – 8.8 (2 – 4)
BMDS-6	5.1 (2.3)	6.5' (2000)	8.8 – 13.2 (4 – 6)
BMDS-8	5.5 (2.5)	6.5' (2000)	13.2 – 17.6 (6 – 8)

SWL = Safe Working Load



## Medium-Duty Long Cable Balancers

4.4 to 30 lb Capacity



- Features**
- Rugged construction, cast aluminum body
  - Stainless-steel cable
  - Adjustable capacity
  - Safety device against load dropping due to the spring breakage (>3 kg)
  - Adjustable stroke limiting device
  - Cable guide in anti-friction material
  - Upper suspension shackle included on balancer for ease of installation

## Medium-Duty Locking Long Cable Balancers

4.4 to 22 lb Capacity



- Features**
- Rugged construction, cast aluminum body
  - Stainless-steel cable
  - Adjustable capacity
  - Safety device against load dropping due to the spring breakage (>3 kg)
  - Adjustable stroke limiting device
  - Cable guide in anti-friction material
  - Equipped with a ratchet locking device to prevent load from retracting when cable is extended
  - Upper suspension shackle included on balancer for ease of installation

Model	lb (kg)	ft (m)	SWL lb (kg)
<b>BMDL SERIES</b>			
BMDLN-4	6.4 (2.9)	8.2' (2500)	4.4 – 8.8 (2 – 4)
BMDLN-6	7.1 (3.2)	8.2' (2500)	8.8 – 13.2 (4 – 6)
BMDLN-8	7.7 (3.5)	8.2' (2500)	13.2 – 17.6 (6 – 8)
BMDLN-10	8.2 (3.7)	8.2' (2500)	17.6 – 22 (8 – 10)
BMDLN-12	8.8 (4)	8.2' (2500)	22 – 30 (10 – 13.6)

Model	lb (kg)	ft (m)	SWL lb (kg)
<b>BMDLL SERIES</b>			
BMDLLN-4	6.6 (3)	8.2' (2500)	4.4 – 8.8 (2 – 4)
BMDLLN-6	7.3 (3.3)	8.2' (2500)	8.8 – 13.2 (4 – 6)
BMDLLN-8	7.9 (3.6)	8.2' (2500)	13.2 – 17.6 (6 – 8)
BMDLLN-10	8.4 (3.8)	8.2' (2500)	17.6 – 22.0 (8 – 10)

## Intermediate-Duty Balancers

8.8 to 55 lb Capacity



- Features**
- Gravity-free suspension capability
  - Ribbed and sealed monobloc construction in aluminum alloy
  - Stainless-steel cable
  - Safety device against load dropping due to the spring breakage (>3 kg)
  - Locking device to block the load at any height
  - Upper rotary suspension with safety hook
  - Adjustable stroke limiting device
  - Cable guide in anti-friction material

## Heavy-Duty Balancers

22 to 143 lb Capacity



- Features**
- Gravity-free suspension capability
  - Ribbed and sealed monobloc construction in aluminum alloy
  - Stainless-steel cable
  - Safety device against load dropping due to the spring breakage (>3 kg)
  - Upper rotary suspension with safety hook
  - Locking device to block the load at any height
  - Adjustable stroke limiting device
  - Cable guide in anti-friction material

Model	lb (kg)	ft (m)	SWL lb (kg)
<b>BID SERIES</b>			
BIDS-7	5 (2.3)	6.5' (2000)	8.8 – 15.4 (4 – 7)
BIDS-10	5.5 (2.5)	6.5' (2000)	15.4 – 22 (7 – 10)
BIDS-14	5.5 (2.5)	6.5' (2000)	22 – 30.8 (10 – 14)
BIDS-18	6.5 (2.9)	6.5' (2000)	30.8 – 39.6 (14 – 18)
BIDS-22	6.5 (2.9)	6.5' (2000)	39.6 – 48.4 (18 – 22)
BIDS-26	6.5 (2.9)	6.5' (2000)	48.4 – 55 (22 – 25)

Model	lb (kg)	ft (m)	SWL lb (kg)
<b>BHD SERIES</b>			
BHD-15	22.7 (10.3)	6.5' (2000)	22 – 33 (10 – 15)
BHD-20	23.4 (10.6)	6.5' (2000)	33 – 44 (15 – 20)
BHD-25	24.7 (11.2)	6.5' (2000)	44 – 55 (20 – 25)
BHD-30	25.4 (11.5)	6.5' (2000)	55 – 66 (25 – 30)
BHD-35	26 (11.8)	6.5' (2000)	66 – 77 (30 – 35)
BHD-45	27.3 (12.4)	6.5' (2000)	77 – 99 (35 – 45)
BHD-55	27.6 (12.5)	6.5' (2000)	99 – 121 (45 – 55)
BHD-65	30 (13.6)	6.5' (2000)	121 – 143 (55 – 65)

SWL = Safe Working Load

## Super-Duty Balancers

33 to 363 lb Capacity



- Features**
- Gravity-free suspension capability
  - Ribbed and sealed monobloc construction in aluminum alloy
  - Stainless-steel cable
  - Safety device against load dropping due to the spring breakage (>3 kg)
  - Upper rotary suspension with safety hook
  - Locking device to block the load at any height
  - Adjustable stroke limiting device
  - Cable guide in anti-friction material
  - Visible cable for inspection

Model	lb (kg)	ft (m)	SWL lb (kg)	Dimension Type
<b>BSD SERIES</b>				
BSD-20	41.9 (18.6)	8.2' (2500)	33 – 44 (15 – 20)	A
BSD-30	43.7 (19.8)	8.2' (2500)	44 – 66 (20 – 30)	A
BSD-40	45.9 (20.8)	8.2' (2500)	66 – 88 (30 – 40)	A
BSD-50	52.7 (23.9)	8.2' (2500)	88 – 110 (40 – 50)	A
BSD-60	56 (25.4)	8.2' (2500)	110 – 132 (50 – 60)	A
BSD-70	59.1 (26.8)	8.2' (2500)	132 – 154 (60 – 70)	B
BSD-80	61.3 (27.8)	8.2' (2500)	154 – 176 (70 – 80)	B
BSD-90	63.5 (28.8)	8.2' (2500)	176 – 198 (80 – 90)	B
BSD-100	78.5 (35.6)	8.2' (2500)	198 – 220 (90 – 100)	C
BSD-120	85.3 (38.8)	8.2' (2500)	220 – 265 (100 – 120)	C
BSD-140	92.2 (41.8)	8.2' (2500)	265 – 309 (120 – 140)	C
BSD-150	98.1 (44.5)	8.2' (2500)	287 – 330 (130 – 150)	C
BSD-165	106.3 (48.2)	8.2' (2500)	330 – 363 (150 – 165)	C

## Balancer Support Systems — Trolleys

### Spring Balancer Series

Rail Type	Trolley Model		
	Intermediate-Duty	Heavy-Duty	Super-Duty
ZRA1	ZHS30304	ZHS30313	ZHS30313
ZRA2	30923	ZHS30314	ZHS30314
ZRS2/3	30842	ZHS30315	ZHS30315
I-Beam	PT005-8	PT005-8	PT005-8

SWL = Safe Working Load

## Super-Duty Long Cable Balancers

33 to 330 lb Capacity



- Features**
- Safety device prevents load dropping
  - Upper suspension with rotary safety hook
  - Precision-guided cable-winding prevents jamming
  - Anti-friction cable guide
  - Manual locking device for instant clamping or release
  - Worm screw capacity adjustment
  - Alignable rotating upper hook
  - Cable replacement without balancer disassembly
  - Cable visible for inspection

Model	lb (kg)	ft (m)	SWL lb (kg)	Dimension Type
<b>BSDL SERIES</b>				
BSD-20	42.1 (19.1)	9.8' (3000)	33 – 44 (15 – 20)	A
BSD-25	43.9 (19.9)	9.8' (3000)	44 – 55 (20 – 25)	A
BSD-35	46.1 (20.9)	9.8' (3000)	55 – 77 (25 – 35)	A
BSD-45	52.5 (23.8)	9.8' (3000)	77 – 99 (35 – 45)	B
BSD-50	52.7 (23.9)	9.8' (3000)	99 – 110 (40 – 50)	B
BSD-60	55.8 (25.3)	9.8' (3000)	110 – 132 (50 – 60)	B
BSD-70	58.9 (26.7)	9.8' (3000)	132 – 154 (60 – 70)	B
BSD-80	61.7 (28)	9.8' (3000)	154 – 176 (70 – 80)	B
BSD-90	64 (29)	9.8' (3000)	176 – 198 (80 – 90)	B
BSD-100	81.1 (36.8)	9.8' (3000)	198 – 220 (90 – 100)	C
BSD-115	85.3 (38.7)	9.8' (3000)	220 – 254 (100 – 115)	C
BSD-130	88 (39.9)	9.8' (3000)	254 – 286 (115 – 130)	C
BSD-140	94.4 (42.8)	9.8' (3000)	286 – 309 (130 – 140)	C
BSD-150	100.6 (45.6)	9.8' (3000)	309 – 330 (140 – 150)	C

## Balancer Accessories

### Floor-Controlled Locking Device

A floor-controlled locking device is available, making it easier to change suspended loads without tension adjustment. The simplicity of this device will minimize downtime when changing a suspended load for a given balancer. Once installed, turn the handle toward red to lock the drum. After load is changed, turn handle toward green to unlock the drum.

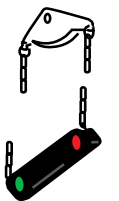

Model	Used With
BIL-7343	Heavy-duty (BHD)
BIL-3224	Super-duty (BSD & BSDL)

## Dimensional Info

**BHR Series**

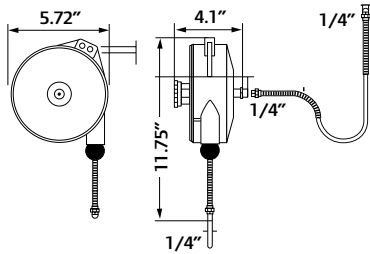

**BLD Series**

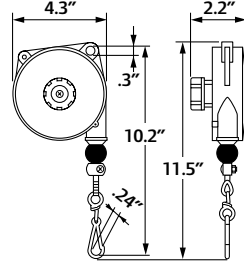

**BMDS Series**

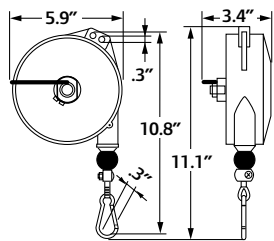

**BMDLN / BMDLLN Series**

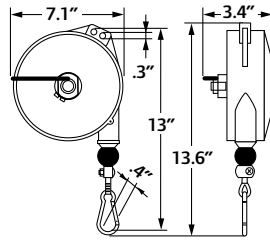

**BIDS Series**

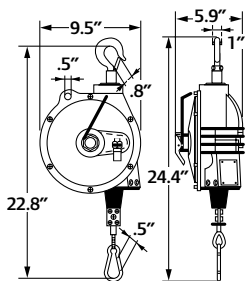

**BHD Series**

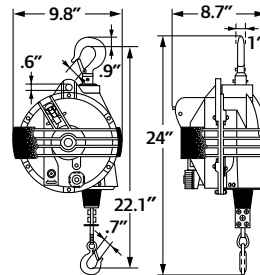

**BSD Series**

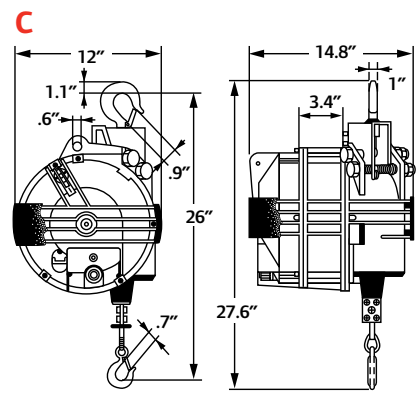
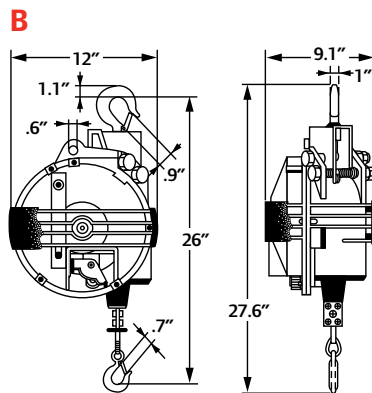
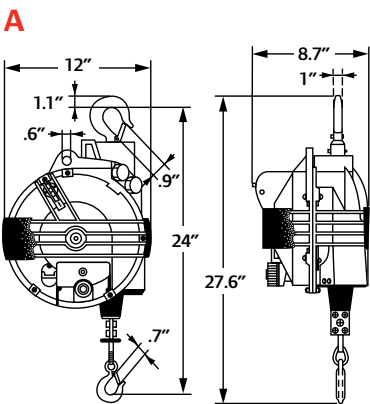

# Torque Reaction Arms





# Torque Reaction Arms

## Bench-mounted QTA Torque Arms

Ingersoll Rand QTA bench-mounted torque reaction arms are constructed of lightweight aluminum and are available in a variety of torque capacities, ranging from 10 to 150 Nm. They include an Ingersoll Rand spring-loaded, die-cast aluminum balancer for impressive strength and reduced weight.

- Spring balancer** adjusts easily and offers effortless vertical movement.
- Simple, proven design** for trouble-free setup and dependability.
- Anodized aluminum body** delivers toughness in a lightweight design.
- Chrome-plated pole** paired with a self-lubricating bearing, provides unmatched durability.
- Position arm at 90° angle** for optimum torque reaction performance. Arm should not be used in fully extended or fully collapsed position as this reduces reaction capabilities.
- Adjustable reach** for easy use and convenience when locating fasteners.
- Cable or air line clamps** keep work area clear and organized.
- Multiple-tool holder options** include right angle, swivel, and pistol grip.
- Custom tool holder options** enable seamless integration with Ingersoll Rand QA and QE tools.

Model	Max. ft-lb (Nm)	SWL lb (kg)	Max. Working Reach in (mm)	in (mm)	H in (mm)
QTA010	7.4 (10)	2.64 (1.20)	15" (381)	13.0" (330)	27.8" (706)
QTA020	14.8 (20)	5.00 (2.27)	20" (508)	14.5" (368)	31.8" (808)
QTA040	29.5 (40)	6.50 (2.95)	25" (635)	17.5" (445)	39.7" (1008)
QTA100	73.8 (100)	8.00 (3.63)	30" (762)	17.5" (445)	39.7" (1008)
QTA150	110.6 (150)	10.00 (4.54)	52" (1321)	22.0" (559)	78.7" (2000)



NOTE: QTA150 is adjustable to mount to the floor or a bench and does not include a tool holder. SWL = Safe Working Load.

## Bench-mounted Arm Accessories

Torque arm accessories include inverse mounting kits to provide mounting to overhead structure and upper pole clamps that help limit travel of the bearing and add support to the top of the arm. Use the table below to select the proper accessory for each torque arm.

Accessories	Torque Arms			
	QTA010	QTA020	QTA040	QTA100
Inverse mounting kit	IMK010	IMK020	IMK100	IMK100
Upper pole clamp	PUC010	PUC020	PUC100	PUC100



## Floor-mounted QTA Torque Arms

When high-torque fastening is required, Ingersoll Rand has two floor-mounted, air-enabled arms from which to choose, with 270 and 475 Nm capacities.

- Generous arm length** makes QTA ideal for assembly line applications.
- Adjustable height control** delivers flexibility for virtually any application.
- Ingersoll Rand air regulator** included with QTA270 and QTA475 arms.
- Safety stop** eliminates over-extending arms.
- Simple design** ensures easy, effective setup and use.
- Custom tool holder options** permit use with Ingersoll Rand QA and QE tools.
- Solid, steel-frame construction** for rugged dependability.

QTA150 can be easily configured for either a bench-mounted or floor-mounted torque arm, and reconfigured as the job demands.

Model	Max. ft-lb (Nm)	SWL lb (kg)	Max. Working Reach in (mm)	in (mm)	H in (mm)
QTA150	110.6 (150)	10.0 (4.5)	52" (1321)	22.0" (559)	78.7" (2000)
QTA270	199 (270)	22.0 (10.0)	60" (1524)	18.8" (477)	78.7" (2000)
QTA475	350 (475)	50.6 (23.0)	79" (2007)	23.2" (590)	78.7" (2000)

Note: Arms above do not include tool holders (please refer to the following page for holders for your Ingersoll Rand tools). SWL = Safe Working Load

QTA270 model shown

Torque Reaction Arms

Torque Reaction Arms

## Torque Arm Tool Holders



Right  
angle



Pistol



Rotating



Push-to-  
start



1/4" NPT



Angle or  
inline

Tool Holders	Torque Arms			
	QTA010	QTA020	QTA040	QTA100
Inline (included with arm)	ITC010-1C	ITC040-1C	ITC040-1C	ITC100-1C
Right angle	ATC010-1C	ATC040-1C	ATC040-1C	ATC100-1C
Pistol	PTC010-1C	PTC040-1C	PTC040-1C	-
Rotating	RTC010-1C	RTC040-1C	RTC040-1C	-
1/4" NPT	NTC010-1T	-	-	-

Generic tool holders are not available for arms 150 Nm and above.

Flange mounting is recommended for in-line tools with torque capacity above 40 Nm.

Note the tool diameter range for generic holders:

QTA010: 25 – 40 mm (1" – 1.57")

QTA020 / QTA040 / QTA100:  
28 – 52 mm (1.1" – 2")

## Ingersoll Rand QA Series and QE Series Tool Holders

Tools	Torque Arms						
	QTA010	QTA020	QTA040	QTA100	QTA150	QTA270	QTA475
QA4 (angle)	-	CTC040-K6B	CTC040-K6B	CTC100-K6B	-	-	-
QA4 (27 Nm max inline) & QA6	-	CTC040-K1B	CTC040-K1B	CTC100-K1B	-	-	-
QA4 (46 Nm inline)	-	-	-	CTC100-K2B	-	-	-
QA8 (150 Nm max angle, 55 Nm max inline)	-	-	CTC040-K1B	CTC100-K1B	CTC150-K2B	-	-
QA8 (above 150 Nm angle, above 55 Nm inline)	-	-	-	CTC100-K2B	CTC150-K3B	CTC270-K3B	-
QE4 (non-push-to-start)	-	CTC040-K1B	CTC040-K1B	-	-	-	-
QE4 (push-to-start)	CTC040-K1P	CTC040-K1P	CTC040-K1P	-	-	-	-
QE6	-	CTC040-K2B	CTC040-K2B	CTC100-K2B	-	-	-
QE8 (using bolt-on flange GEM120-K48)	-	-	-	CTC100-K2B	CTC150-K2B	-	-
QE8 (using integrated flanged gear case)	-	-	-	CTC100-K3B	CTC150-K3B	CTC270-K3B	-
QE8 (230 Nm in-line)	-	-	-	-	-	CTC270-K4B	-
QE8 (400 Nm angle)	-	-	-	-	-	-	CTC475-K5B

Note: Every Ingersoll Rand QE- or QA-specific tool holder listed in the table above accepts both angle and inline tools but requires an integrated flanged gear case or bolt-on mounting flange to attach the tool holder to the tool. If your tool came with mounting style "P," "R," or "J," order Part No. 15E4-K48 for any Ingersoll Rand-specific tool holder that ends with "1B." Order Part No. GEM120-K48 for any Ingersoll Rand-specific tool holder that ends with "2B." Order Part No. QA4-K48 for any Ingersoll Rand-specific tool holder that ends with "6B."

## Light-Duty Work Arms

These steel-constructed, lightweight workstations offer the operator tool flexibility while supporting the tool weight. Add a torque absorber rod to help relieve minor torque reaction forces while fastening.

Model	Description
IRBS3-EO	Basic station (no absorber)
IRBS3-N30	Air tool station with torque absorber
IRBS3-E30	Electric tool station with torque absorber

Note: Workstations do not include tool, spring balancer, air hose, or FRL. All must be purchased separately.



# Grips & Braces





## Grips & Braces

Grips and braces are designed to provide comfort and better control while using the tool. They help minimize reaction forces and vibrations to prevent harmful effects to extremities.

### Ergo-Grips™



Part Number	Description	For Use With
<b>ERGO-GRIPS</b>		
SEG3AH-CL	Ergo-Grip (over 1,700 rpm)	Cleco
SEG3A-IR	Ergo-Grip (1,650 rpm or less)	Ingersoll Rand 3 Series
SEG3-AR	Ergo-Grip (1,500 rpm or less)	ARO 20 Series
SEG4-AR	Ergo-Grip (1,700 rpm or less)	ARO 50 Series
SEG4-CL	Ergo-Grip (1,000 rpm or less)	Cleco
SEG4H-AR	Ergo-Grip (over 1,700 rpm)	ARO 50 Series
SEG4H-CL	Ergo-Grip (over 1,000 rpm)	Cleco
SEG4H-IR	Ergo-Grip (over 1,200 rpm)	Ingersoll Rand 4 Series
SEG4-IR	Ergo-Grip (1,200 rpm or less)	Ingersoll Rand 4 Series
SEG4-CGK	Replacement foam grip kit	Series SEG4

- Ergo-Grip™ makes tool operation more comfortable with reduced grip pressure and vibration dampening
- Easy installation:
  1. Unscrew clutch housing.
  2. Slip on grip.
  3. Reattach housing.

### Bio-Braces™



SBB4-IR

Part Number	Description	For Use With
<b>BIO-BRACES</b>		
SBB4-AR	Bio-brace (over 1,700 rpm)	ARO 50 Series
SBB4-IR	Bio-brace (over 1,200 rpm)	Ingersoll Rand 4 Series
SBB4-VS	Bio-brace	Ingersoll Rand Versatec Series
SBB4-QE2	Bio-brace	QE2 Series
SEG3A-CGK	Replacement foam grip kit	SEG3A Series

- Ergonomically designed Bio Brace™ minimizes start-up and shut-off force to your arm.
- Eliminates the need for a dead handle, freeing up your other hand.

# Lubricants & Grease Guns



## Lubricants & Grease Guns

It goes without saying that proper lubrication of any tool is essential if you want the tool to last. By lubricating your air tools, you'll prolong the life of tool motors, mechanisms, gearing, and other vital parts. Ingersoll Rand offers a complete line of specialized oils and greases that are engineered specifically for use with our air tools. Also, grease guns are available for your convenience to dispense the line of lubricants.



10Z4



10P



10G

### Air Tools Oils

Part Number	Description	Size
<b>AIR TOOL OILS</b>		
63Z4	#63 oil for cyclone wick lubrication	4 oz
10Z4	Class 1 #10 oils for use with percussive, assembly, and impact wrenches	4oz
10P	Class 1 #10 oils for use with percussive, assembly, and impact wrenches	1 pt
10G	Class 1 #10 oils for use with percussive, assembly, and impact wrenches	1 gal
10G55	Class 1 #10 oils for use with percussive, assembly, and impact wrenches	55 gal
10GW	Class 1 #10 oil and antifreeze for use with percussive, assembly, and impact wrenches	1 gal
50P	Class II lubricant, #50 oil for use with grinders, impact wrenches, hoists, and winches	1 pt
50G	Class II lubricant, #50 oil for use with grinders, impact wrenches, hoists, and winches	1 gal
62 1 Gal	Class II #62 oil for hoist and winch gear boxes	1 gal

## Greases

Part Number	Description	Grease No.	Size
<b>GREASES</b>			
23-1 LB	For the gearing of drills	23	1 lb
28 1 LB	For screwdriver gearing and clutches; drills, grinders, saws; tie tamper grease	28	1 lb
66 1 LB	For slow-speed, high-torque angle heads	66	1 lb
66 8 LB	For slow-speed, high-torque angle heads	66	8 lb
67-4T	For high-speed, high-temp angle heads (green)	67	4 oz
67-1 LB	For high-speed, high-temp angle heads (green)	67	1 lb
67 8 LB	For high-speed, high-temp angle heads (green)	67	8 lb
68-1LB	Coupling splines and high speed angle heads	68	1 lb
68 8 LB	Coupling splines and high speed angle heads	68	8 lb
70 1 LB	For large-piston motors and gear cases	70	1 lb
70 8 LB	For large-piston motors and gear cases	70	8 lb
77-1 LB	For grinder angle heads	77	1 lb
80 1 LB	For bearings on sump pumps	80	1 lb
80 8 LB	For bearings on sump pumps	80	8 lb
90-14 OZ	For gear heads and tube nut wrenches	90	14 oz
100 1 LB	Standard-duty impact wrench grease	100	1 lb
100 8 LB	Standard-duty impact wrench grease	100	8 lb
105-4T	Metallic housing impact wrench grease	105	4 oz
105-1LB	Metallic housing impact wrench grease	105	1 lb
105-8LB	Metallic housing impact wrench grease	105	8 lb
115-4T	Composite housing impact wrench grease	115	4 oz
115-1LB	Composite housing impact wrench grease	115	1 lb
150-1 LB	For impact mechanisms with swinging weight	150	1 lb
150 8 LB	For impact mechanisms with swinging weight	150	8 lb
170-1LB	Premium impact grease for high temps, used with impact mechanisms	170	1 lb



105-4T



100 1 lb



### Lubrication Kits



105-LBK1

Part Number	Description
<b>LUBRICATION KITS</b>	
67-LBK1	Angle grinder care kit includes 10Z4 oil, 4 oz, 67 grease, and grease gun
105-LBK1	Metallic housings impact wrench care kit includes 10Z4 oil, 4 oz, 105 grease, and grease gun
115-LBK1	Composite housings impact wrench care kit includes 10Z4 oil, 4 oz, 115 grease, and grease gun

The 10Z4, 10P, 10G, 100-1LB, 105-LBK1, & 115-LBK1 are available in case quantities. See the website for quantities and part numbers.

### Grease Guns

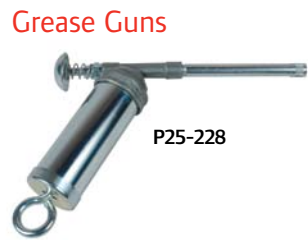

P25-228

### Grease Tube Head











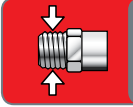

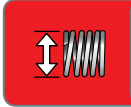

GTH-1

Part Number	Description
<b>GREASE GUNS</b>	
P25-228	Push-type hand grease gun for hydraulic-type fittings, holds up to 3 oz of grease
R000A2-228	Push-type hand grease gun for flush-type fittings, holds up to 3 oz of grease
<b>GREASE TUBE HEAD</b>	
GTH-1	Grease gun used with Ingersoll Rand 4 oz tube of grease

## Glossary of Technical Symbols

For ease of use, specification tables frequently use symbols in column headings. Please reference the chart below for exact descriptions.

	NPT size		Hose inner diameter
	Max. working pressure		Hose outer diameter
	Max. air consumption		Coiled hose height
	Max. torque		Coiled hose width
	Weight		Coiled hose working length
	Lift		Length
	Capacity		
	Approximate travel		
	Overall height		

Distributed by:



Ingersoll Rand Industrial Technologies provides products, services and solutions that enhance our customers' energy efficiency, productivity and operations. Our diverse and innovative products range from complete compressed air systems, tools and pumps to material and fluid handling systems and environmentally friendly microturbines. We also enhance productivity through solutions created by Club Car®, the global leader in golf and utility vehicles for businesses and individuals.

(800) 376-TOOL • [irtools.com](http://irtools.com)